

LA FILTRATION

Catalogue Produit 2017 2019



Qualité



Embouts
aluminium

Service



Embouts
Inox



Stock



Embouts
Plastique

evo@air
AIR COMPRIMÉ

Conseil

EVOAIR

EVOAIR

Traitement d'Air & Gaz

evo@air

AIR COMPRIMÉ

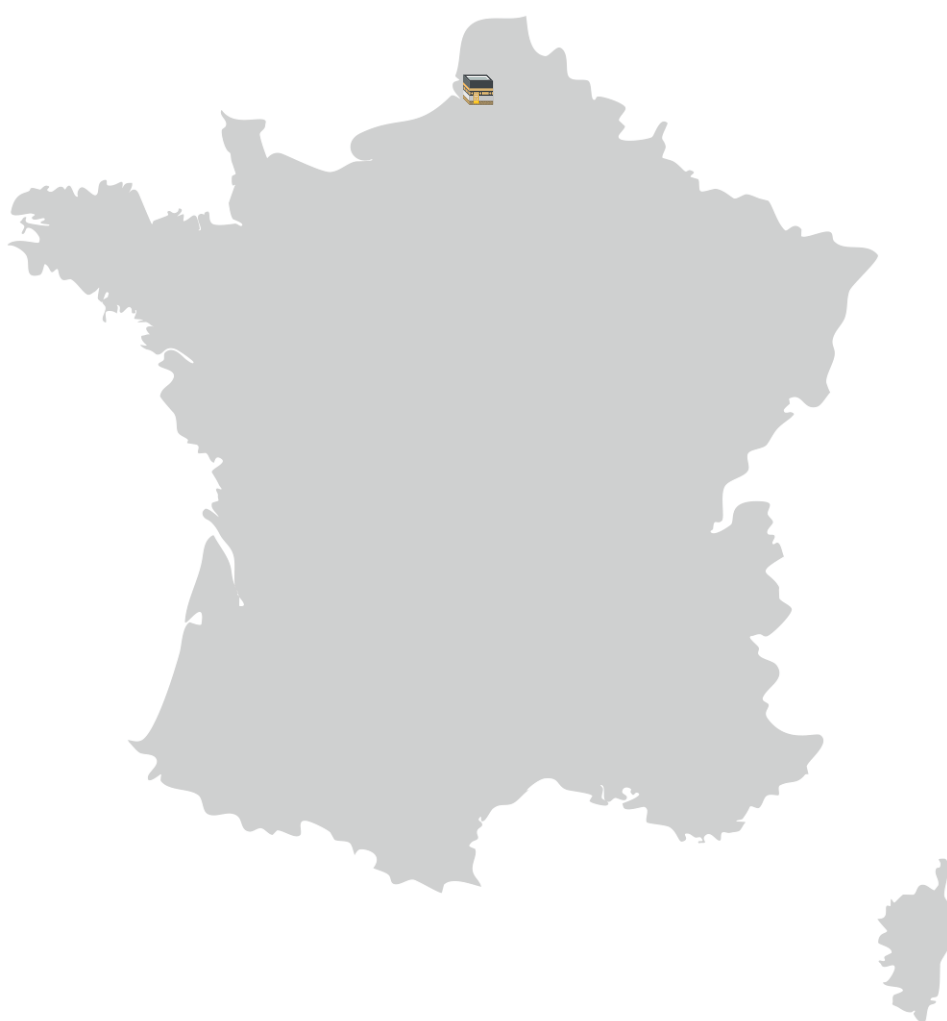

EVOAIR
AIR COMPRIME

T +33 (0)3 22 26 82 12

contact@evoair.fr

65, rue du 11 Novembre
80220 Gamaches, France
www.evoair.fr



SOMMAIRE

ELEMENTS FILTRANTS ALTERNATIFS

- | | | | | | |
|----|--|----|--|----|---|
| 6 | EVOAIR
Embout plastique | 31 | CECCATO (nouveaux)
Embout plastique | 65 | EKOMAK
Embout plastique |
| 7 | EVOAIR
Embout Aluminium | 32 | CECCATO (anciens)
Embout plastique | 66 | EKOMAK
Embout Aluminium |
| 8 | ABAC
Embout plastique | 33 | CHICHAGO PNEUMATIC (nouveaux)
Embout plastique | 67 | FIAC
Embout plastique |
| 9 | AGRE
Embout plastique | 34 | CHICHAGO PNEUMATIC (anciens)
Embout plastique | 68 | FINITE J
Embout Aluminium |
| 10 | AIRFILTER ENGINEERING
Embout plastique | 35 | COMPAIR
Embout plastique | 70 | FINITE (anciens)
Embout Aluminium |
| 11 | AIRFILTER ENGINEERING
Embout Aluminium | 36 | COMPAIR (anciens)
Embout plastique | 71 | FUSHENG (nouveaux)
Embout plastique |
| 12 | ALMIG
Embout plastique | 37 | COMPAIR (anciens)
Embout Aluminium | 72 | FUSHENG (ancien)
Embout plastique |
| 13 | ALUP (nouveaux)
Embout plastique | 38 | DELTECH 300
Embout plastique | 73 | FUSHENG (ancien)
Embout Aluminium |
| 14 | ALUP (anciens)
Embout plastique | 39 | DELTECH
Embout Aluminium | 74 | HANKISON NGF
Embout plastique |
| 15 | ALUP (anciens)
Embout plastique | 40 | DOMNICK HUNTER oil-x evolution
Embout plastique | 75 | HANKISON
Embout Aluminium |
| 16 | ATLAS COPCO +
Embout plastique | 42 | DOMNICK HUNTER oil-x plus
Embout plastique | 76 | HIROSS (nouveaux)
Embout plastique |
| 17 | ATLAS COPCO
Embout plastique | 44 | DOMNICK HUNTER oil-x plus
Embout plastique | 77 | HIROSS (nouveaux)
Embout Aluminium |
| 18 | ATLAS COPCO
Embout Aluminium | 45 | DOMNICK HUNTER HT
Embout plastique | 78 | HIROSS (ancien)
Embout plastique |
| 19 | ATLAS COPCO (ancien)
Embout plastique | 46 | DOMNICK HUNTER NH3
Embout Aluminium | 79 | HIROSS (ancien)
Embout Aluminium |
| 20 | ATLAS COPCO (ancien)
Embout Aluminium | 47 | DONALDSON DF
Embout plastique | 80 | INGERSOLL RAND AC
Embout plastique |
| 21 | ATS
Embout plastique | 50 | DONALDSON séries 90'
Embout plastique | 81 | INGERSOLL RAND F
Embout plastique |
| 22 | BALMA
Embout plastique | 52 | DONALDSON SÉRIES 90'
Embout Aluminium | 82 | INGERSOLL RAND FA
Embout plastique |
| 24 | BEA ARS
Embout Aluminium | 54 | DONALDSON SÉRIES 80'
Embout Aluminium | 83 | KAESER (nouveaux)
Embout plastique |
| 25 | BEA ARV
Embout Aluminium | 56 | Eléments filtrants exempts de silicone et graisse
DONALDSON
Embouts exempts de silicone et graisses | 84 | KAESER (anciens)
Embout Aluminium |
| 26 | BEA BST
Embout Aluminium | 58 | Eléments filtrants exempts de silicone et graisses
DONALDSON
Embouts exempts de silicone et graisses | 85 | KNOCKS
Embout Aluminium |
| 27 | BEKO
Embout plastique | 60 | Eléments filtrants stérile/vent
DONALDSON
Embout Inox 1.4301 (304) | 86 | KOBELCO
Embout plastique |
| 28 | BOGE (nouveaux)
Embout plastique | 64 | Eléments filtrants de process
DONALDSON
Embout Inox 1.4301 (304) | 87 | KSI
Embout plastique |
| 30 | BOGE (anciens)
Embout plastique | | | 88 | MARK (nouveaux)
Embout plastique |



- 89 **MARK (ancien)**
Embout plastique
- 90 **MATTEI OMAT**
Embout plastique
- 91 **MAUGUIERE (nouveaux)**
Embout plastique
- 92 **MAUGUIERE (anciens)**
Embout plastique
- 93 **MIKROPOR G**
Embout Aluminium
- 94 **OMI ALps**
Embout plastique
- 95 **OMI (ancien)**
Embout plastique
- 96 **ORION (nouveau)**
Embout Aluminium
- 97 **PNEUMATECH (nouveaux)**
Embout plastique
- 98 **PNEUMATECH (anciens)**
Embout plastique
- 99 **PREVOST MICRO**
Embout plastique
- 100 **PREVOST**
Embout Aluminium
- 101 **PUSKA**
Embout plastique
- 102 **SCHNEIDER**
Embout plastique
- 103 **SMC**
Embout Aluminium
- 104 **SPX NGF**
Embout plastique
- 105 **SULLAIR**
Embout plastique
- 106 **WALKER OWA ALfa**
Embout plastique
- 107 **WALKER**
Embout Aluminium
- 108 **WALKER HP**
Embout Aluminium
- 109 **WORTHINGTON CREYSSENSAC (nouv.)**
Embout plastique
- 110 **WORTHINGTON CREYSSENSAC (anciens)**
Embout plastique
- 111 **ZANDER GL**
Embout plastique

- 112 **ZANDER**
Embout plastique
- 113 **ZANDER**
Embout plastique
- 114 **Eléments filtrants stérile/vent**
ZANDER
Embout Inox 1.4301 (304)
- 116 **Eléments filtrant de process**
ZANDER
Embout Inox 1.4301 (304)
- 118 **ZONDER**
Embout plastique

CORPS DE FILTRE ALTERNATIFS

- 122 **DONALDSON**
- 122 **DOMNICK HUNTER**

ELEMENTS SEPARATEUR EAU/HUILE ALTERNATIFS

- 124 **JORC**
(Boge, Partenair)
- 124 **BEKO**
(Atlas Copco, Kaeser, Ecoair, Schnider)
- 124 **WORTMANN**
(Zander, Kaeser, Hankinson)
- 125 **DOMNICK HUNTER**
(Hiross, Zander, Hiross, Compar, INGERSOLL RAND)
- 125 **DONALDSON**
(Almig, Gardner Denver)
- 125 **KAESER**
- 126 **ATLAS COPCO**
(Alup, Abac)
- 126 **OMI**
(Devair)

CARTOUCHES DE DESSICANT ALTERNATIVES POUR SECHEURS

- 127 **DONALDSON**
Ultrapac 2000







KITS DE MAINTENANCE ALTERNATIFS POUR SECHEUR

- 128 **HANKISON**

DEMANDE DE DEVIS

- 130 **DEVIS**

EVOAIR (filtres EAF)

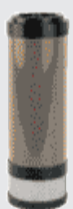
	B	P	R	M	S	A	A ² (5)	H ² (5)
EVOAIR Embouts Plastique								
Retention particules	15 µm	3 µm	1 µm	0,1 µm	0,01 µm	Cha. act.	Adoption	Catalyse
Classe de qualité - solides ⁽¹⁾	7	6	3	2	1	1 ⁽⁴⁾	1 ⁽⁴⁾	1 ⁽⁴⁾
Classe de qualité - Huile ⁽¹⁾	-	-	-	2	1	1	0/1	-
Media Filtrant	laièn fritté	fibres acrylique, cellulose	micro fibres de borosilicate			micro fibres de borosilicate Charbon actif	micro fibres de borosilicate Charbon actif	micro fibres de borosilicate hopcalite
Température de fct.[°C]	1,5 à 65	1,5 à 65	1,5 à 65	1,5 à 65	1,5 à 65	1,5 à 45	1,5 à 45	1,5 à 45
DP (élément neuf) [mbar]	20	10	20	50	80	60	voir Spec.	voir Spec.
Remplacer à [mbar]	⁽²⁾	350	350	350	350	6 mois ⁽³⁾	6 mois ⁽³⁾	6 mois ⁽³⁾

Element pour filtre	B	P	R	M	S	A	A ²	H ²
EAF 0056	E_06050 B15	E_06050 P	E_06050 R	E_06050 M	E_06050 S	E_06050 A	E_06050 A ²	E_06050 H ²
EAF 0076	E_07050 B15	E_07050 P	E_07050 R	E_07050 M	E_07050 S	E_07050 A	E_07050 A ²	E_07050 H ²
EAF 0106	E_14050 B15	E_14050 P	E_14050 R	E_14050 M	E_14050 S	E_14050 A	E_14050 A ²	E_14050 H ²
EAF 0186	E_12075 B15	E_12075 P	E_12075 R	E_12075 M	E_12075 S	E_12075 A	E_12075 A ²	E_12075 H ²
EAF 0306	E_22075 B15	E_22075 P	E_22075 R	E_22075 M	E_22075 S	E_22075 A	E_22075 A ²	E_22075 H ²
EAF 0476	E_32075 B15	E_32075 P	E_32075 R	E_32075 M	E_32075 S	E_32075 A	E_32075 A ²	E_32075 H ²
EAF 0706	E_50075 B15	E_50075 P	E_50075 R	E_50075 M	E_50075 S	E_50075 A	E_50075 A ²	E_50075 H ²
EAF 0946	E_51090 B15	E_51090 P	E_51090 R	E_51090 M	E_51090 S	E_51090 A	E_51090 A ²	E_51090 H ²
EAF 1506	E_76090 B15	E_76090 P	E_76090 R	E_76090 M	E_76090 S	E_76090 A	E_76090 A ²	E_76090 H ²
EAF 1756	E_76090 B15	E_76090 P	E_76090 R	E_76090 M	E_76090 S	E_76090 A	E_76090 A ²	E_76090 H ²
EAF 2006	E_51140 B15	E_51140 P	E_51140 R	E_51140 M	E_51140 S	E_51140 A	E_51140 A ²	E_51140 H ²
EAF 2406	E_75140 B15	E_75140 P	E_75140 R	E_75140 M	E_75140 S	E_75140 A	E_75140 A ²	E_75140 H ²

⁽¹⁾: Suivant ISO 8573-1







⁽²⁾ Les cartouches B doivent être nettoyées dans un bac à ultrason ou par rinçage. Les intervalles de nettoyage dépendent de l'application. Remplacer la cartouche si nécessaire.

⁽³⁾ Les cartouches "A, A², H²", doivent être remplacées régulièrement, au bout d'une période de 6 mois maximum. Les filtres à charbon actif ne doivent pas être utilisés dans des conditions saturées en huile.

⁽⁴⁾ Valide si une cartouche S est installée en amont.





⁽⁵⁾ Pour les Eléments filtrants A², H² et MS², il est nécessaire de réduire le débit, en fonction des données techniques fournies.

EVOAIR (filtres EBF)

	B	P	R	M	S	A
EVOAIR Embouts Aluminium						
Retention particules	15 µm	3 µm	1 µm	0,1 µm	0,01 µm	Cha. act.
Classe de qualité - solides ⁽¹⁾	7	6	3	2	1	1 ⁽⁴⁾
Classe de qualité - Huile ⁽¹⁾	-	-	-	2	1	1
Media Filtrant	laiàn frité	fibres acrylique, cellulose	micro fibres de borosilicate			micro fibres de borosilicate Charbon actif
Température de fct.[°C]	1,5 à 65	1,5 à 65	1,5 à 65	1,5 à 65	1,5 à 65	1,5 à 45
DP (élément neuf) [mbar]	20	10	20	50	80	60
Remplacer à [mbar]	⁽²⁾	350	350	350	350	6 mois ⁽³⁾
	B	P	R	M	S	A
	E_76090 B15Al	E_76090 P_AI	E_76090 R_AI	E_76090 R_AI	E_76090 S_AI	E_76090 A_AI

ELEMENTS FILTRANTS ALTERNATIFS

ABAC





	MBP	MBM	MBS	MBA
ABAC Embouts Plastique				
Retention particules	3 µm	0,1 µm	0,01 µm	charbon actif
Classe de qualité - solides ⁽¹⁾	6	2	1	1*
Classe de qualité - Huile ⁽¹⁾	-	2	1	1
Media Filtrant	fibres acrylique, cellulose	micro fibres de borosilicate		micro fibres deborosilicate Charbon actif
Température de fct.[°C]	1,5 à 65	1,5 à 65	1,5 à 65	1,5 à 45
DP (élément neuf) [mbar]	10	50	80	60

	MBP		MBM		MBS		MBA	
	ABAC	EVOAIR	ABAC	EVOAIR	ABAC	EVOAIR	ABAC	EVOAIR
MBP 60		EAB 60 MBP/P	MBM 60	EAB 60 MBM/M	MBS 60	EAB 60 MBS/S	MBA 60	EAB 60 MBA/A
MBP 80		EAB 80 MBP/P	MBM 80	EAB 80 MBM/M	MBS 80	EAB 80 MBS/S	MBA 80	EAB 80 MBA/A
MBP 120		EAB 120 MBP/P	MBM 120	EAB 120 MBM/M	MBS 120	EAB 120 MBS/S	MBA 120	EAB 120 MBA/A
MBP 200		EAB 200 MBP/P	MBM 200	EAB 200 MBM/M	MBS 200	EAB 200 MBS/S	MBA 200	EAB 200 MBA/A
MBP 340		EAB 340 MBP/P	MBM 340	EAB 340 MBM/M	MBS 340	EAB 340 MBS/S	MBA 340	EAB 340 MBA/A
MBP 510		EAB 510 MBP/P	MBM 510	EAB 510 MBM/M	MBS 510	EAB 510 MBS/S	MBA 510	EAB 510 MBA/A
MBP 800		EAB 800 MBP/P	MBM 800	EAB 800 MBM/M	MBS 800	EAB 800 MBS/S	MBA 800	EAB 800 MBA/A
MBP 1000		EAB 1000 MBP/P	MBM 1000	EAB 1000 MBM/M	MBS 1000	EAB 1000 MBS/S	MBA 1000	EAB 1000 MBA/A
MBP 1500		EAB 1500 MBP/P	MBM 1500	EAB 1500 MBM/M	MBS 1500	EAB 1500 MBS/S	MBA 1500	EAB 1500 MBA/A
MBP 2400		EAB 2400 MBP/P	MBM 2400	EAB 2400 MBM/M	MBS 2400	EAB 2400 MBS/S	MBA 2400	EAB 2400 MBA/A

NOTE: * Valide si une cartouche filtrante "S" est installé en mont.

ELEMENTS FILTRANTS ALTERNATIFS





AGRE

	MBP	MBM	MBS	MBA
AGRE Embouts Plastique				
Retention particules	3 µm	0,1 µm	0,01 µm	charbon actif
Classe de qualité - solides ⁽¹⁾	6	2	1	1*
Classe de qualité - Huile ⁽¹⁾	-	2	1	1
Media Filtrant	fibres acrylique, cellulose	micro fibres de borosilicate		micro fibres deborosilicate Charbon actif
Température de fct. [°C]	1,5 à 65	1,5 à 65	1,5 à 65	1,5 à 45
DP (élément neuf) [mbar]	10	50	80	60

	MBP		MBM		MBS		MBA	
	AGRE	EVOAIR	AGRE	EVOAIR	AGRE	EVOAIR	AGRE	EVOAIR
MBP 60		EAG 60 MBP/P	MBM 60	EAG 60 MBM/M	MBS 60	EAG 60 MBS/S	MBA 60	EAG 60 MBA/A
MBP 80		EAG 80 MBP/P	MBM 80	EAG 80 MBM/M	MBS 80	EAG 80 MBS/S	MBA 80	EAG 80 MBA/A
MBP 120		EAG 120 MBP/P	MBM 120	EAG 120 MBM/M	MBS 120	EAG 120 MBS/S	MBA 120	EAG 120 MBA/A
MBP 200		EAG 200 MBP/P	MBM 200	EAG 200 MBM/M	MBS 200	EAG 200 MBS/S	MBA 200	EAG 200 MBA/A
MBP 340		EAG 340 MBP/P	MBM 340	EAG 340 MBM/M	MBS 340	EAG 340 MBS/S	MBA 340	EAG 340 MBA/A
MBP 510		EAG 510 MBP/P	MBM 510	EAG 510 MBM/M	MBS 510	EAG 510 MBS/S	MBA 510	EAG 510 MBA/A
MBP 800		EAG 800 MBP/P	MBM 800	EAG 800 MBM/M	MBS 800	EAG 800 MBS/S	MBA 800	EAG 800 MBA/A
MBP 1000		EAG 1000 MBP/P	MBM 1000	EAG 1000 MBM/M	MBS 1000	EAG 1000 MBS/S	MBA 1000	EAG 1000 MBA/A
MBP 1500		EAG 1500 MBP/P	MBM 1500	EAG 1500 MBM/M	MBS 1500	EAG 1500 MBS/S	MBA 1500	EAG 1500 MBA/A
MBP 2400		EAG 2400 MBP/P	MBM 2400	EAG 2400 MBM/M	MBS 2400	EAG 2400 MBS/S	MBA 2400	EAG 2400 MBA/A

NOTE: * Valide si une cartouche filtrante "S" est installée en amont.





AIRFILTER ENGINEERING

	P	U	H	S	C
AIRFILTER ENGINEERING Embouts Plastique					
	Retention particules	3 µm	1 µm	0,1 µm	0,01 µm
Classe de qualité - solides ⁽¹⁾	6	3	2	1	1*
Classe de qualité - Huile ⁽¹⁾	-	-	2	1	1
Media Filtrant	fibres acrylique, cellulose			micro fibres de borosilicate	
Température de fct. [°C]	1,5 à 65	1,5 à 65	1,5 à 65	1,5 à 65	1,5 à 45
DP (élément neuf) [mbar]	10	20	50	80	60

	P		U		H		S		C	
	AIRFILTER ENGINEERING	EVOAIR	AIRFILTER ENGINEERING	EVOAIR	AIRFILTER ENGINEERING	EVOAIR	AIRFILTER ENGINEERING	EVOAIR	AIRFILTER ENGINEERING	EVOAIR
EA10 P	EAFA EA10 P/P	EA10 U	EAFA EA10 U/R	EA10 H	EAFA EA10 H/M	EA10 S	EAFA EA10 S/S	EA10 C	EAFA EA10 C/A	
EA15 P	EAFA EA15 P/P	EA15 U	EAFA EA15 U/R	EA15 H	EAFA EA15 H/M	EA15 S	EAFA EA15 S/S	EA15 C	EAFA EA15 C/A	
EA20 P	EAFA EA20 P/P	EA20 U	EAFA EA20 U/R	EA20 H	EAFA EA20 H/M	EA20 S	EAFA EA20 S/S	EA20 C	EAFA EA20 C/A	
EA30 P	EAFA EA30 P/P	EA30 U	EAFA EA30 U/R	EA30 H	EAFA EA30 H/M	EA30 S	EAFA EA30 S/S	EA30 C	EAFA EA30 C/A	
EA55 P	EAFA EA55 P/P	EA55 U	EAFA EA55 U/R	EA55 H	EAFA EA55 H/M	EA55 S	EAFA EA55 S/S	EA55 C	EAFA EA55 C/A	
EA95 P	EAFA EA95 P/P	EA95 U	EAFA EA95 U/R	EA95 H	EAFA EA95 H/M	EA95 S	EAFA EA95 S/S	EA95 C	EAFA EA95 C/A	
EA150 P	EAFA EA150 P/P	EA150 U	EAFA EA150 U/R	EA150 H	EAFA EA150 H/M	EA150 S	EAFA EA150 S/S	EA150 C	EAFA EA150 C/A	
EA220 P	EAFA EA220 P/P	EA220 U	EAFA EA220 U/R	EA220 H	EAFA EA220 H/M	EA220 S	EAFA EA220 S/S	EA220 C	EAFA EA220 C/A	
EA290 P	EAFA EA290 P/P	EA290 U	EAFA EA290 U/R	EA290 H	EAFA EA290 H/M	EA290 S	EAFA EA290 S/S	EA290 C	EAFA EA290 C/A	
EA430 P	EAFA EA430 P/P	EA430 U	EAFA EA430 U/R	EA430 H	EAFA EA430 H/M	EA430 S	EAFA EA430 S/S	EA430 C	EAFA EA430 C/A	
EA625 P	EAFA EA625 P/P	EA625 U	EAFA EA625 U/R	EA625 H	EAFA EA625 H/M	EA625 S	EAFA EA625 S/S	EA625 C	EAFA EA625 C/A	
EA775 P	EAFA EA775 P/P	EA775 U	EAFA EA775 U/R	EA775 H	EAFA EA775 H/M	EA775 S	EAFA EA775 S/S	EA775 C	EAFA EA775 C/A	

NOTE: * Valide si une cartouche filtrante "S" est installée en amont.

AIRFILTER ENGINEERING





AIRFILTER ENGINEERING Embouts Aluminium	P	U	H	S	C
					
Retention particules	3 µm	1 µm	0,1 µm	0,01 µm	charbon actif
Classe de qualité - solides ⁽¹⁾	6	3	2	1	1*
Classe de qualité - Huile ⁽¹⁾	-	-	2	1	1
Media Filtrant	fibres acrylique, cellulose				micro fibres de borosilicate Charbon actif
Température de fct. [°C]	1,5 à 65	1,5 à 65	1,5 à 65	1,5 à 65	1,5 à 45
DP (élément neuf) [mbar]	10	20	50	80	60

AIRFILTER ENGINEERING	P	U	H	S	C				
	EVOAIR	EVOAIR	EVOAIR	EVOAIR	EVOAIR				
EA10 P	EAFE EA10 P/P AL	EA10 U	EAFE EA10 U/R AL	EA10 H	EAFE EA10 H/M AL	EA10 S	EAFE EA10 S/S AL	EA10 C	EAFE EA10 C/A AL
EA15 P	EAFE EA15 P/P AL	EA15 U	EAFE EA15 U/R AL	EA15 H	EAFE EA15 H/M AL	EA15 S	EAFE EA15 S/S AL	EA15 C	EAFE EA15 C/A AL
EA20 P	EAFE EA20 P/P AL	EA20 U	EAFE EA20 U/R AL	EA20 H	EAFE EA20 H/M AL	EA20 S	EAFE EA20 S/S AL	EA20 C	EAFE EA20 C/A AL
EA30 P	EAFE EA30 P/P AL	EA30 U	EAFE EA30 U/R AL	EA30 H	EAFE EA30 H/M AL	EA30 S	EAFE EA30 S/S AL	EA30 C	EAFE EA30 C/A AL
EA55 P	EAFE EA55 P/P AL	EA55 U	EAFE EA55 U/R AL	EA55 H	EAFE EA55 H/M AL	EA55 S	EAFE EA55 S/S AL	EA55 C	EAFE EA55 C/A AL
EA95 P	EAFE EA95 P/P AL	EA95 U	EAFE EA95 U/R AL	EA95 H	EAFE EA95 H/M AL	EA95 S	EAFE EA95 S/S AL	EA95 C	EAFE EA95 C/A AL
EA150 P	EAFE EA150 P/P AL	EA150 U	EAFE EA150 U/R AL	EA150 H	EAFE EA150 H/M AL	EA150 S	EAFE EA150 S/S AL	EA150 C	EAFE EA150 C/A AL
EA220 P	EAFE EA220 P/P AL	EA220 U	EAFE EA220 U/R AL	EA220 H	EAFE EA220 H/M AL	EA220 S	EAFE EA220 S/S AL	EA220 C	EAFE EA220 C/A AL
EA290 P	EAFE EA290 P/P AL	EA290 U	EAFE EA290 U/R AL	EA290 H	EAFE EA290 H/M AL	EA290 S	EAFE EA290 S/S AL	EA290 C	EAFE EA290 C/A AL
EA430 P	EAFE EA430 P/P AL	EA430 U	EAFE EA430 U/R AL	EA430 H	EAFE EA430 H/M AL	EA430 S	EAFE EA430 S/S AL	EA430 C	EAFE EA430 C/A AL
EA625 P	EAFE EA625 P/P AL	EA625 U	EAFE EA625 U/R AL	EA625 H	EAFE EA625 H/M AL	EA625 S	EAFE EA625 S/S AL	EA625 C	EAFE EA625 C/A AL
EA775 P	EAFE EA775 P/P AL	EA775 U	EAFE EA775 U/R AL	EA775 H	EAFE EA775 H/M AL	EA775 S	EAFE EA775 S/S AL	EA775 C	EAFE EA775 C/A AL

NOTE: * Valide si une cartouche filtrante "S" est installée en amont.

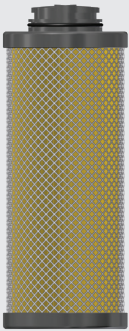
ELEMENTS FILTRANTS ALTERNATIFS





ALMIG

	AFP	AFM	AFS	AFC
ALMIG Embouts Plastique				
Retention particules	3 µm	0,1 µm	0,01 µm	charbon actif
Classe de qualité - solides ⁽¹⁾	6	2	1	1*
Classe de qualité - Huile ⁽¹⁾	-	2	1	1
Media Filtrant	fibres acrylique, cellulose	micro fibres de borosilicate		micro fibres deborosilicate Charbon actif
Température de fct.[°C]	1,5 à 65	1,5 à 65	1,5 à 65	1,5 à 45
DP (élément neuf) [mbar]	10	50	80	60

	AFP		AFM		AFS		AFC	
	ALMIG	EVOAIR	ALMIG	EVOAIR	ALMIG	EVOAIR	ALMIG	EVOAIR
AFP 30		EALM 30 AFP/P	AFM 30	EALM 30 AFM/M	AFS 30	EALM 30 AFS/S	AFC 30	EALM 30 AFC/A
AFP 60		EALM 60 AFP/P	AFM 60	EALM 60 AFM/M	AFS 60	EALM 60 AFS/S	AFC 60	EALM 60 AFC/A
AFP 108		EALM 108 AFP/P	AFM 108	EALM 108 AFM/M	AFS 108	EALM 108 AFS/S	AFC 108	EALM 108 AFC/A
AFP 180		EALM 180 AFP/P	AFM 180	EALM 180 AFM/M	AFS 180	EALM 180 AFS/S	AFC 180	EALM 180 AFC/A
AFP 204		EALM 204 AFP/P	AFM 204	EALM 204 AFM/M	AFS 204	EALM 204 AFS/S	AFC 204	EALM 204 AFC/A
AFP 300		EALM 300 AFP/P	AFM 300	EALM 300 AFM/M	AFS 300	EALM 300 AFS/S	AFC 300	EALM 300 AFC/A
AFP 432		EALM 432 AFP/P	AFM 432	EALM 432 AFM/M	AFS 432	EALM 432 AFS/S	AFC 432	EALM 432 AFC/A
AFP 570		EALM 570 AFP/P	AFM 570	EALM 570 AFM/M	AFS 570	EALM 570 AFS/S	AFC 570	EALM 570 AFC/A
AFP 750		EALM 750 AFP/P	AFM 750	EALM 750 AFM/M	AFS 750	EALM 750 AFS/S	AFC 750	EALM 750 AFC/A
AFP 990		EALM 990 AFP/P	AFM 990	EALM 990 AFM/M	AFS 990	EALM 990 AFS/S	AFC 990	EALM 990 AFC/A
AFP 1140		EALM 1140 AFP/P	AFM 1140	EALM 1140 AFM/M	AFS 1140	EALM 1140 AFS/S	AFC 1140	EALM 1140 AFC/A
AFP 1320		EALM 1320 AFP/P	AFM 1320	EALM 1320 AFM/M	AFS 1320	EALM 1320 AFS/S	AFC 1320	EALM 1320 AFC/A
AFP 1680		EALM 1680 AFP/P	AFM 1680	EALM 1680 AFM/M	AFS 1680	EALM 1680 AFS/S	AFC 1680	EALM 1680 AFC/A
AFP 2100		EALM 2100 AFP/P	AFM 2100	EALM 2100 AFM/M	AFS 2100	EALM 2100 AFS/S	AFC 2100	EALM 2100 AFC/A
AFP 2640		EALM 2640 AFP/P	AFM 2640	EALM 2640 AFM/M	AFS 2640	EALM 2640 AFS/S	AFC 2640	EALM 2640 AFC/A

NOTE: * Valide si une cartouche filtrante "S" est installée en amont.





ALUP (nouveau)

	P	G	C	V
ALUP (nouveau) Embouts Plastique				
Retention particules	1 µm	0,1 µm	0,01 µm	charbon actif
Classe de qualité - solides ⁽¹⁾	3	2	1	1*
Classe de qualité - Huile ⁽¹⁾	-	2	1	1
Media Filtrant	micro fibres de borosilicate			micro fibres de borosilicate Charbon actif
Température de fct.[°C]	1,5 à 65	1,5 à 65	1,5 à 65	1,5 à 45
DP (élément neuf) [mbar]	20	50	80	60

	P		G		C		V	
	ALUP	EVOAIR	ALUP	EVOAIR	ALUP	EVOAIR	ALUP	EVOAIR
FILTER 45	EALU 45 P/R		FILTER 45	EALU 45 G/M	FILTER 45	EALU 45 C/S	FILTER 45	EALU 45 V/A
FILTER 90	EALU 90 P/R		FILTER 90	EALU 90 G/M	FILTER 90	EALU 90 C/S	FILTER 90	EALU 90 V/A
FILTER 125	EALU 125 P/R		FILTER 125	EALU 125 G/M	FILTER 125	EALU 125 C/S	FILTER 125	EALU 125 V/A
FILTER 180	EALU 180 P/R		FILTER 180	EALU 180 G/M	FILTER 180	EALU 180 C/S	FILTER 180	EALU 180 V/A
FILTER 290	EALU 290 P/R		FILTER 290	EALU 290 G/M	FILTER 290	EALU 290 C/S	FILTER 290	EALU 290 V/A
FILTER 505	EALU 505 P/R		FILTER 505	EALU 505 G/M	FILTER 505	EALU 505 C/S	FILTER 505	EALU 505 V/A
FILTER 685	EALU 685 P/R		FILTER 685	EALU 685 G/M	FILTER 685	EALU 685 C/S	FILTER 685	EALU 685 V/A
FILTER 935	EALU 935 P/R		FILTER 935	EALU 935 G/M	FILTER 935	EALU 935 C/S	FILTER 935	EALU 935 V/A
FILTER 1295	EALU 1295 P/R		FILTER 1295	EALU 1295 G/M	FILTER 1295	EALU 1295 C/S	FILTER 1295	EALU 1295 V/A
FILTER 1890	EALU 1890 P/R		FILTER 1890	EALU 1890 G/M	FILTER 1890	EALU 1890 C/S	FILTER 1890	EALU 1890 V/A
FILTER 2430	EALU 2430 P/R		FILTER 2430	EALU 2430 G/M	FILTER 2430	EALU 2430 C/S	FILTER 2430	EALU 2430 V/A

NOTE: * Valide si une cartouche filtrante "S" est installée en amont.





ALUP (precedents)

	MBP	MBM	MBS	MBA
ALUP (precedents) Embouts Plastique				
Retention particules	3 µm	0,1 µm	0,01 µm	charbon actif
Classe de qualité - solides ⁽¹⁾	6	2	1	1*
Classe de qualité - Huile ⁽¹⁾	-	2	1	1
Media Filtrant	fibres acrylique, cellulose	micro fibres de borosilicate		micro fibres deborosilicate Charbon actif
Température de fct. [°C]	1,5 à 65	1,5 à 65	1,5 à 65	1,5 à 45
DP (élément neuf) [mbar]	10	50	80	60

	MBP		MBM		MBS		MBA	
	ALUP	EVOAIR	ALUP	EVOAIR	ALUP	EVOAIR	ALUP	EVOAIR
MBP 60	EALU 60 MBP/P		MBM 60	EALU 60 MBM/M	MBS 60	EALU 60 MBS/S	MBA 60	EALU 60 MBA/A
MBP 80	EALU 80 MBP/P		MBM 80	EALU 80 MBM/M	MBS 80	EALU 80 MBS/S	MBA 80	EALU 80 MBA/A
MBP 120	EALU 120 MBP/P		MBM 120	EALU 120 MBM/M	MBS 120	EALU 120 MBS/S	MBA 120	EALU 120 MBA/A
MBP 200	EALU 200 MBP/P		MBM 200	EALU 200 MBM/M	MBS 200	EALU 200 MBS/S	MBA 200	EALU 200 MBA/A
MBP 340	EALU 340 MBP/P		MBM 340	EALU 340 MBM/M	MBS 340	EALU 340 MBS/S	MBA 340	EALU 340 MBA/A
MBP 510	EALU 510 MBP/P		MBM 510	EALU 510 MBM/M	MBS 510	EALU 510 MBS/S	MBA 510	EALU 510 MBA/A
MBP 800	EALU 800 MBP/P		MBM 800	EALU 800 MBM/M	MBS 800	EALU 800 MBS/S	MBA 800	EALU 800 MBA/A
MBP 1000	EALU 1000 MBP/P		MBM 1000	EALU 1000 MBM/M	MBS 1000	EALU 1000 MBS/S	MBA 1000	EALU 1000 MBA/A
MBP 1500	EALU 1500 MBP/P		MBM 1500	EALU 1500 MBM/M	MBS 1500	EALU 1500 MBS/S	MBA 1500	EALU 1500 MBA/A
MBP 2400	EALU 2400 MBP/P		MBM 2400	EALU 2400 MBM/M	MBS 2400	EALU 2400 MBS/S	MBA 2400	EALU 2400 MBA/A

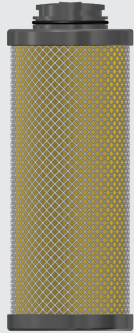
NOTE: * Valide si une cartouche filtrante "S" est installée en amont.





ALUP (anciens)

	AFP	AFM	AFS	AFC
ALUP (anciens) Embouts Plastique				
	Retention particules	3 µm	0,1 µm	0,01 µm
Classe de qualité - solides ⁽¹⁾	6	2	1	1*
Classe de qualité - Huile ⁽¹⁾	-	2	1	1
Media Filtrant	fibres acrylique, cellulose	micro fibres de borosilicate		micro fibres deborosilicate Charbon actif
Température de fct.[°C]	1,5 à 65	1,5 à 65	1,5 à 65	1,5 à 45
DP (élément neuf) [mbar]	10	50	80	60

	AFP		AFM		AFS		AFC			
	ALUP	EVOAIR	ALUP	EVOAIR	ALUP	EVOAIR	ALUP	EVOAIR		
AFP 30	EALU 30 AFP/P		AFM 30	EALU 30 AFM/M		AFS 30	EALU 30 AFS/S		AFC 30	EALU 30 AFC/A
AFP 60	EALU 60 AFP/P		AFM 60	EALU 60 AFM/M		AFS 60	EALU 60 AFS/S		AFC 60	EALU 60 AFC/A
AFP 108	EALU 108 AFP/P		AFM 108	EALU 108 AFM/M		AFS 108	EALU 108 AFS/S		AFC 108	EALU 108 AFC/A
AFP 180	EALU 180 AFP/P		AFM 180	EALU 180 AFM/M		AFS 180	EALU 180 AFS/S		AFC 180	EALU 180 AFC/A
AFP 204	EALU 204 AFP/P		AFM 204	EALU 204 AFM/M		AFS 204	EALU 204 AFS/S		AFC 204	EALU 204 AFC/A
AFP 300	EALU 300 AFP/P		AFM 300	EALU 300 AFM/M		AFS 300	EALU 300 AFS/S		AFC 300	EALU 300 AFC/A
AFP 432	EALU 432 AFP/P		AFM 432	EALU 432 AFM/M		AFS 432	EALU 432 AFS/S		AFC 432	EALU 432 AFC/A
AFP 570	EALU 570 AFP/P		AFM 570	EALU 570 AFM/M		AFS 570	EALU 570 AFS/S		AFC 570	EALU 570 AFC/A
AFP 750	EALU 750 AFP/P		AFM 750	EALU 750 AFM/M		AFS 750	EALU 750 AFS/S		AFC 750	EALU 750 AFC/A
AFP 990	EALU 990 AFP/P		AFM 990	EALU 990 AFM/M		AFS 990	EALU 990 AFS/S		AFC 990	EALU 990 AFC/A
AFP 1140	EALU 1140 AFP/P		AFM 1140	EALU 1140 AFM/M		AFS 1140	EALU 1140 AFS/S		AFC 1140	EALU 1140 AFC/A
AFP 1320	EALU 1320 AFP/P		AFM 1320	EALU 1320 AFM/M		AFS 1320	EALU 1320 AFS/S		AFC 1320	EALU 1320 AFC/A
AFP 1680	EALU 1680 AFP/P		AFM 1680	EALU 1680 AFM/M		AFS 1680	EALU 1680 AFS/S		AFC 1680	EALU 1680 AFC/A
AFP 2100	EALU 2100 AFP/P		AFM 2100	EALU 2100 AFM/M		AFS 2100	EALU 2100 AFS/S		AFC 2100	EALU 2100 AFC/A
AFP 2640	EALU 2640 AFP/P		AFM 2640	EALU 2640 AFM/M		AFS 2640	EALU 2640 AFS/S		AFC 2640	EALU 2640 AFC/A

NOTE: * Valide si une cartouche filtrante "S" est installée en amont.



ATLAS COPCO +

	DD	PD	UD	QD
ATLAS COPCO + Embouts Plastique				
Retention particules	0,1 µm	0,01 µm	0,01 µm	charbon actif
Classe de qualité - solides ⁽¹⁾	2	1	1	1*
Classe de qualité - Huile ⁽¹⁾	2	1	1	1
Media Filtrant	micro fibres de borosilicate			charbon actif
Température de fct.[°C]	1,5 à 65	1,5 à 65	1,5 à 65	1,5 à 45
DP (élément neuf) [mbar]	50	80	80	60

	DD		PD		UD		QD	
	ATLAS COPCO	EVOAIR	ATLAS COPCO	EVOAIR	ATLAS COPCO	EVOAIR	ATLAS COPCO	EVOAIR
10+ DD		EAC +10 DD/M	10+ PD	EAC +10 PD/S	9+ UD	EAC +9 UD/S	10+ QD	EAC +10 QD/A
20+ DD		EAC +20 DD/M	20+ PD	EAC +20 PD/S	15+ UD	EAC +15 UD/S	20+ QD	EAC +20 QD/A
35+ DD		EAC +35 DD/M	35+ PD	EAC +35 PD/S	25+ UD	EAC +25 UD/S	35+ QD	EAC +35 QD/A
50+ DD		EAC +50 DD/M	50+ PD	EAC +50 PD/S	45+ UD	EAC +45 UD/S	50+ QD	EAC +50 QD/A
70+ DD		EAC +70 DD/M	70+ PD	EAC +70 PD/S	60+ UD	EAC +60 UD/S	70+ QD	EAC +70 QD/A
-		E	-	E	100+ UD	EAC +100 UD/S	-	E
130+ DD		EAC +130 DD/M	130+ PD	EAC +130 PD/S	140+ UD	EAC +140 UD/S	130+ QD	EAC +130 QD/A
170+ DD		EAC +170 DD/M	170+ PD	EAC +170 PD/S	180+ UD	EAC +180 UD/S	170+ QD	EAC +170 QD/A
210+ DD		EAC +210 DD/M	210+ PD	EAC +210 PD/S	220+ UD	EAC +220 UD/S	210+ QD	EAC +210 QD/A
310+ DD		EAC +310 DD/M	310+ PD	EAC +310 PD/S	310+ UD	EAC +310 UD/S	310+ QD	EAC +310 QD/A
425+ DD		EAC +425 DD/M	425+ PD	EAC +425 PD/S	425+ UD	EAC +425 UD/S	425+ QD	EAC +425 QD/A
550+ DD		EAC +550 DD/M	550+ PD	EAC +550 PD/S	550+ UD	EAC +550 UD/S	550+ QD	EAC +550 QD/A

NOTE: * Valide si une cartouche filtrante "S" est installée en amont.

ATLAS COPCO

ATLAS COPCO Embouts Plastique	DD	PD	QD
			
Retention particules	0,1 µm	0,01 µm	charbon actif
Classe de qualité - solides ⁽¹⁾	2	1	1**
Classe de qualité - Huile ⁽¹⁾	2	1	1
Media Filtrant	micro fibres de borosilicate		charbon actif
Température de fct.[°C]	1,5 à 65	1,5 à 65	1,5 à 45
DP (élément neuf) [mbar]	50	80	60



	DD		PD		QD	
	ATLAS COPCO	EVOAIR	ATLAS COPCO	EVOAIR	ATLAS COPCO	EVOAIR
DD 9		EAC 9 DD/M	PD 9	EAC 9 PD/S	QD 9	OAC 9 QD/A
DD 17		EAC 17 DD/M	PD 17	EAC 17 PD/S	QD 17	OAC 17 QD/A
DD 32		EAC 32 DD/M	PD 32	EAC 32 PD/S	QD 32	OAC 32 QD/A
DD 44		EAC 44 DD/M	PD 44	EAC 44 PD/S	QD 44	OAC 44 QD/A
DD 60		EAC 60 DD/M	PD 60	EAC 60 PD/S	QD 60	OAC 60 QD/A
DD 120		EAC 120 DD/M	PD 120	EAC 120 PD/S	QD 120	OAC 120 QD/A
DD 150		EAC 150 DD/M	PD 150	EAC 150 PD/S	QD 150	OAC 150 QD/A
DD 175		EAC 175 DD/M	PD 175	EAC 175 PD/S	QD 175	OAC 175 QD/A
DD 260/DD 280		EAC 260 DD/M*	PD 260/PD 280	EAC 260 PD/S*	QD 260/QD 280	OAC 260 QD/A*
DD 390		EAC 390 DD/M	PD 390	EAC 390 PD/S	QD 390	OAC 390 QD/A
DD 520		EAC 520 DD/M	PD 520	EAC 520 PD/S	QD 520	OAC 520 QD/A

NOTE:

* Embouts Aluminium

** Valide si une cartouche filtrante "S" est installée en amont.



ATLAS COPCO

	DD	PD	QD
ATLAS COPCO			
Embouts Aluminium			
Retention particules	0,1 µm	0,01 µm	charbon actif
Classe de qualité - solides ⁽¹⁾	2	1	1*
Classe de qualité - Huile ⁽¹⁾	2	1	1
Media Filtrant	micro fibres de borosilicate		charbon actif
Température de fct. [°C]	1,5 à 65	1,5 à 65	1,5 à 45
DP (élément neuf) [mbar]	50	80	60

	DD		PD		QD	
	ATLAS COPCO	EVOAIR	ATLAS COPCO	EVOAIR	ATLAS COPCO	EVOAIR
DD 9	EAC 9 DD/M AL	PD 9	EAC 9 PD/S AL	QD 9	EAC 9 QD/A AL	
DD 17	EAC 17 DD/M AL	PD 17	EAC 17 PD/S AL	QD 17	EAC 17 QD/A AL	
DD 32	EAC 32 DD/M AL	PD 32	EAC 32 PD/S AL	QD 32	EAC 32 QD/A AL	
DD 44	EAC 44 DD/M AL	PD 44	EAC 44 PD/S AL	QD 44	EAC 44 QD/A AL	
DD 60	EAC 60 DD/M AL	PD 60	EAC 60 PD/S AL	QD 60	EAC 60 QD/A AL	
DD 120	EAC 120 DD/M AL	PD 120	EAC 120 PD/S AL	QD 120	EAC 120 QD/A AL	
DD 150	EAC 150 DD/M AL	PD 150	EAC 150 PD/S AL	QD 150	EAC 150 QD/A AL	
DD 175	EAC 175 DD/M AL	PD 175	EAC 175 PD/S AL	QD 175	EAC 175 QD/A AL	
DD 260 DD 280	EAC 260 DD/M AL	PD 260 PD 280	EAC 260 PD/S AL	QD 260 QD 280	EAC 260 QD/A AL	
DD 390	EAC 390 DD/M AL	PD 390	EAC 390 PD/S AL	QD 390	EAC 390 QD/A AL	
DD 520	EAC 520 DD/M AL	PD 520	EAC 520 PD/S AL	QD 520	EAC 520 QD/A AL	
DD 520F	EAC 520F DD/M AL	PD 520F	EAC 520F PD/S AL	QD 520F	EAC 520F QD/A AL	
DD 780F	EAC 780F DD/M AL	PD 780F	EAC 780F PD/S AL	QD 780F	EAC 780F QD/A AL	
DD 850F	EAC 850F DD/M AL	PD 850F	EAC 850F PD/S AL	QD 850F	EAC 850F QD/A AL	

NOTE: * Valide si une cartouche filtrante "S" est installée en amont.

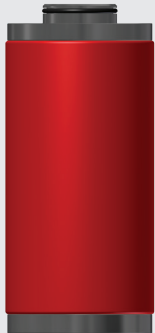

ATLAS COPCO (ancien)

	DD	PD	QD
ATLAS COPCO (ancien) Embouts Plastique			
Retention particules	0,1 µm	0,01 µm	charbon actif
Classe de qualité - solides ⁽¹⁾	2	1	1*
Classe de qualité - Huile ⁽¹⁾	2	1	1
Media Filtrant	micro fibres de borosilicate		charbon actif
Température de fct. [°C]	1,5 à 65	1,5 à 65	1,5 à 45
DP (élément neuf) [mbar]	50	80	60

	DD		PD		QD	
	ATLAS COPCO	EVOAIR	ATLAS COPCO	EVOAIR	ATLAS COPCO	EVOAIR
DD 6		EAC 6 DD/M	PD 6	EAC 6 PD/S	QD 6	EAC 6 QD/A
DD 13		EAC 13 DD/M	PD 13	EAC 13 PD/S	QD 13	EAC 13 QD/A
DD 25		EAC 25 DD/M	PD 25	EAC 25 PD/S	QD 25	EAC 25 QD/A
DD 40		EAC 40 DD/M	PD 40	EAC 40 PD/S	QD 40	EAC 40 QD/A
DD 65/DD 85		EAC 65 DD/M	PD 65/PD 85	EAC 65 PD/S	QD 65/QD 85	EAC 65 QD/A
DD 170/DD 195		EAC 195 DD/M	PD 170/PD 195	EAC 195 PD/S	QD 170/QD 195	EAC 195 QD/A
DD 295		EAC 295 DD/M	PD 295	EAC 295 PD/S	QD 295	EAC 295 QD/A
DD 375/DD 400		EAC 400 DD/M	PD 375/PD 400	EAC 400 PD/S	QD 375/QD 400	EAC 400 QD/A
DD 450/DD 500		EAC 500 DD/M	PD 450/PD 500	EAC 500 PD/S	QD 450/QD 500	EAC 500 QD/A

NOTE: * Valide si une cartouche filtrante "S" est installée en amont.

ATLAS COPCO (ancien)





	DD	PD	QD
ATLAS COPCO (ancien) Embouts Aluminium			
	Retention particules	0,1 µm	0,01 µm
Classe de qualité - solides ⁽¹⁾	2	1	1*
Classe de qualité - Huile ⁽¹⁾	2	1	1
Media Filtrant	micro fibres de borosilicate		charbon actif
Température de fct. [°C]	1,5 à 65	1,5 à 65	1,5 à 45
DP (élément neuf) [mbar]	50	80	60

	DD		PD		QD	
	ATLAS COPCO	EVOAIR	ATLAS COPCO	EVOAIR	ATLAS COPCO	EVOAIR
DD 6	EAC 6 DD/M AL	PD 6	EAC 6 PD/S AL	QD 6	EAC 6 QD/A AL	
DD 13	EAC 13 DD/M AL	PD 13	EAC 13 PD/S AL	QD 13	EAC 13 QD/A AL	
DD 25	EAC 25 DD/M AL	PD 25	EAC 25 PD/S AL	QD 25	EAC 25 QD/A AL	
DD 40	EAC 40 DD/M AL	PD 40	EAC 40 PD/S AL	QD 40	EAC 40 QD/A AL	
DD 65/DD 85	EAC 65 DD/M AL	PD 65/PD 85	EAC 65 PD/S AL	QD 65/QD 85	EAC 65 QD/A AL	
DD 170/DD 195	EAC 195 DD/M AL	PD 170/PD 195	EAC 195 PD/S AL	QD 170/QD 195	EAC 195 QD/A AL	
DD 295	EAC 295 DD/M AL	PD 295	EAC 295 PD/S AL	QD 295	EAC 295 QD/A AL	
DD 375/DD 400	EAC 400 DD/M AL	PD 375/PD 400	EAC 400 PD/S AL	QD 375/QD 400	EAC 400 QD/A AL	
DD 450/DD 500	EAC 500 DD/M AL	PD 450/PD 500	EAC 500 PD/S AL	QD 450/QD 500	EAC 500 QD/A AL	

NOTE: * Valide si une cartouche filtrante "S" est installée en amont.

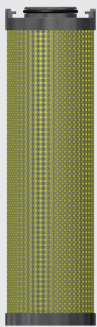
ELEMENTS FILTRANTS ALTERNATIFS

ATS

	P	M	H	C
ATS Embouts Plastique				
Retention particules	3 µm	1 µm	0,01 µm	charbon actif
Classe de qualité - solides ⁽¹⁾	6	3	1	1*
Classe de qualité - Huile ⁽¹⁾	-	-	1	1
Media Filtrant	fibres acrylique, cellulose	micro fibres de borosilicate		charbon actif
Température de fct. [°C]	1,5 à 65	1,5 à 65	1,5 à 65	1,5 à 45
DP (élément neuf) [mbar]	10	20	80	60





	P		M		H		C	
	ATS	EVOAIR	ATS	EVOAIR	ATS	EVOAIR	ATS	EVOAIR
0034E; 0020EP	EAT 34 P/P		0034E; 0020EM	EAT 34 M/R	0034E; 0020EH	EAT 34 H/S	0034E; 0020EC	EAT 34 C/A
0077E; 0045EP	EAT 77 P/P		0077E; 0045EM	EAT 77 M/R	0077E; 0045EH	EAT 77 H/S	0077E; 0045EC	EAT 77 C/A
0119E; 0070EP	EAT 119 P/P		0119E; 0070EM	EAT 119 M/R	0119E; 0070EH	EAT 119 H/S	0119E; 0070EC	EAT 119 C/A
0170E; 0100EP	EAT 170 P/P		0170E; 0100EM	EAT 170 M/R	0170E; 0100EH	EAT 170 H/S	0170E; 0100EC	EAT 170 C/A
0212E; 0125EP	EAT 212 P/P		0212E; 0125EM	EAT 212 M/R	0212E; 0125EH	EAT 212 H/S	0212E; 0125EC	EAT 212 C/A
0306E; 0180EP	EAT 306 P/P		0306E; 0180EM	EAT 306 M/R	0306E; 0180EH	EAT 306 H/S	0306E; 0180EC	EAT 306 C/A
0451E; 0265EP	EAT 451 P/P		0451E; 0265EM	EAT 451 M/R	0451E; 0265EH	EAT 451 H/S	0451E; 0265EC	EAT 451 C/A
0629E; 0370EP	EAT 629 P/P		0629E; 0370EM	EAT 629 M/R	0629E; 0370EH	EAT 629 H/S	0629E; 0370EC	EAT 629 C/A
0875E; 0515EP	EAT 875 P/P		0875E; 0515EM	EAT 875 M/R	0875E; 0515EH	EAT 875 H/S	0875E; 0515EC	EAT 875 C/A
1267E; 0745EP	EAT 1267 P/P		1267E; 0745EM	EAT 1267 M/R	1267E; 0745EH	EAT 1267 H/S	1267E; 0745EC	EAT 1267 C/A
1800E; 1060EP	EAT 1800 P/P		1800E; 1060EM	EAT 1800 M/R	1800E; 1060EH	EAT 1800 H/S	1800E; 1060EC	EAT 1800 C/A
2176E; 1280EP	EAT 2176 P/P		2176E; 1280EM	EAT 2176 M/R	2176E; 1280EH	EAT 2176 H/S	2176E; 1280EC	EAT 2176 C/A
2805E; 1650EP	EAT 2805 P/P		2805E; 1650EM	EAT 2805 M/R	2805E; 1650EH	EAT 2805 H/S	2805E; 1650EC	EAT 2805 C/A

NOTE: * Valide si une cartouche filtrante "S" est installée en amont.

EVOAIR

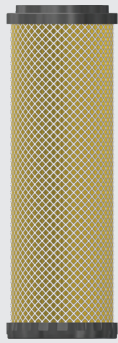
Traitement de l'Air & des Gaz

BALMA



	MBP	MBM	MBS	MBA
BALMA Embouts Plastique				
Retention particules	3 µm	0,1 µm	0,01 µm	charbon actif
Classe de qualité - solides ⁽¹⁾	6	2	1	1*
Classe de qualité - Huile ⁽¹⁾	-	2	1	1
Media Filtrant	fibres acrylique, cellulose	micro fibres de borosilicate		charbon actif
Température de fct. [°C]	1,5 à 65	1,5 à 65	1,5 à 65	1,5 à 45
DP (élément neuf) [mbar]	10	50	80	60

	MBP		MBM		MBS		MBA	
	BALMA	EVOAIR	BALMA	EVOAIR	BALMA	EVOAIR	BALMA	EVOAIR
MBP 60		EBA 60 MBP/P	MBM 60	EBA 60 MBM/M	MBS 60	EBA 60 MBS/S	MBA 60	EBA 60 MBA/A
MBP 80		EBA 80 MBP/P	MBM 80	EBA 80 MBM/M	MBS 80	EBA 80 MBS/S	MBA 80	EBA 80 MBA/A
MBP 120		EBA 120 MBP/P	MBM 120	EBA 120 MBM/M	MBS 120	EBA 120 MBS/S	MBA 120	EBA 120 MBA/A
MBP 200		EBA 200 MBP/P	MBM 200	EBA 200 MBM/M	MBS 200	EBA 200 MBS/S	MBA 200	EBA 200 MBA/A
MBP 340		EBA 340 MBP/P	MBM 340	EBA 340 MBM/M	MBS 340	EBA 340 MBS/S	MBA 340	EBA 340 MBA/A
MBP 510		EBA 510 MBP/P	MBM 510	EBA 510 MBM/M	MBS 510	EBA 510 MBS/S	MBA 510	EBA 510 MBA/A
MBP 800		EBA 800 MBP/P	MBM 800	EBA 800 MBM/M	MBS 800	EBA 800 MBS/S	MBA 800	EBA 800 MBA/A
MBP 1000		EBA 1000 MBP/P	MBM 1000	EBA 1000 MBM/M	MBS 1000	EBA 1000 MBS/S	MBA 1000	EBA 1000 MBA/A
MBP 1500		EBA 1500 MBP/P	MBM 1500	EBA 1500 MBM/M	MBS 1500	EBA 1500 MBS/S	MBA 1500	EBA 1500 MBA/A
MBP 2400		EBA 2400 MBP/P	MBM 2400	EBA 2400 MBM/M	MBS 2400	EBA 2400 MBS/S	MBA 2400	EBA 2400 MBA/A

NOTE: * Valide si une cartouche filtrante "S" est installée en amont.



ELEMENTS FILTRANTS
ALTERNATIFS

BEA ARS

	RM	RF	RB
BEA Embouts Aluminium			
Retention particules	3 µm	1 µm	0,1 µm
Classe de qualité - solides ⁽¹⁾	3	3	1
Classe de qualité - Huile ⁽¹⁾	-	-	1
Media Filtrant	micro fibres de borosilicate		
Température de fct.[°C]	1,5 à 65	1,5 à 65	1,5 à 65
DP (élément neuf) [mbar]	20	20	80

	RM		RF		RB	
	BEA	EVOAIR	BEA	EVOAIR	BEA	EVOAIR
ARS-15 RM		EBE ARS15 RM/P AL	ARS-15 RF	EBE ARS15 RF/R AL	ARS-15 RB	EBE ARS15 RB/M AL
ARS-30 RM		EBE ARS30 RM/P AL	ARS-30 RF	EBE ARS30 RF/R AL	ARS-30 RB	EBE ARS30 RB/M AL
ARS-100 RM		EBE ARS100 RM/P AL	ARS-100 RF	EBE ARS100 RF/R AL	ARS-100 RB	EBE ARS100 RB/M AL
ARS-180 RM		EBE ARS180 RM/P AL	ARS-180 RF	EBE ARS180 RF/R AL	ARS-180 RB	EBE ARS180 RB/M AL
ARS-290 RM		EBE ARS290 RM/P AL	ARS-290 RF	EBE ARS290 RF/R AL	ARS-290 RB	EBE ARS290 RB/M AL
ARS-460 RM		EBE ARS460 RM/P AL	ARS-460 RF	EBE ARS460 RF/R AL	ARS-460 RB	EBE ARS460 RB/M AL
ARS-610 RM		EBE ARS610 RM/P AL	ARS-610 RF	EBE ARS610 RF/R AL	ARS-610 RB	EBE ARS610 RB/M AL
ARS-930 RM		EBE ARS930 RM/P AL	ARS-930 RF	EBE ARS930 RF/R AL	ARS-930 RB	EBE ARS930 RB/M AL
ARS-1050 RM		EBE ARS1050 RM/P AL	ARS-1050 RF	EBE ARS1050 RF/R AL	ARS-1050 RB	EBE ARS1050 RB/M AL
ARS-1250 RM		EBE ARS1250 RM/P AL	ARS-1250 RF	EBE ARS1250 RF/R AL	ARS-1250 RB	EBE ARS1250 RB/M AL
ARS-1400 RM		EBE ARS1400 RM/P AL	ARS-1400 RF	EBE ARS1400 RF/R AL	ARS-1400 RB	EBE ARS1400 RB/M AL
ARS-2300 RM		EBE ARS2300 RM/P AL	ARS-2300 RF	EBE ARS2300 RF/R AL	ARS-2300 RB	EBE ARS2300 RB/M AL

NOTE: * Valide si une cartouche filtrante "S" est installée en amont.

	RA	CA
BEA Embouts Aluminium		
Retention particules	0,01 µm	0,1 µm
Classe de qualité - solides ⁽¹⁾	1	2
Classe de qualité - Huile ⁽¹⁾	1	2
Media Filtrant	micro fibres de borosilicate	
Température de fct. [°C]	1,5 à 65	1,5 à 65
DP (élément neuf) [mbar]	80	50

	RA		CA	
	BEA	EVOAIR	BEA	EVOAIR
ARS-15 RA	EBE ARS15 RA/S AL	ARS-15 CA	EBE ARS15 CA/A AL	
ARS-30 RA	EBE ARS30 RA/S AL	ARS-30 CA	EBE ARS30 CA/A AL	
ARS-100 RA	EBE ARS100 RA/S AL	ARS-100 CA	EBE ARS100 CA/A AL	
ARS-180 RA	EBE ARS180 RA/S AL	ARS-180 CA	EBE ARS180 CA/A AL	
ARS-290 RA	EBE ARS290 RA/S AL	ARS-290 CA	EBE ARS290 CA/A AL	
ARS-460 RA	EBE ARS460 RA/S AL	ARS-460 CA	EBE ARS460 CA/A AL	
ARS-610 RA	EBE ARS610 RA/S AL	ARS-610 CA	EBE ARS610 CA/A AL	
ARS-930 RA	EBE ARS930 RA/S AL	ARS-930 CA	EBE ARS930 CA/A AL	
ARS-1050 RA	EBE ARS1050 RA/S AL	ARS-1050 CA	EBE ARS1050 CA/A AL	
ARS-1250 RA	EBE ARS1250 RA/S AL	ARS-1250 CA	EBE ARS1250 CA/A AL	
ARS-1400 RA	EBE ARS1400 RA/S AL	ARS-1400 CA	EBE ARS1400 CA/A AL	
ARS-2300 RA	EBE ARS2300 RA/S AL	ARS-2300 CA	EBE ARS2300 CA/A AL	





NOTE: * Valide si une cartouche filtrante "S" est installée en amont.

BEA ARV

	DA-VAC	
	BEA	EVOAIR
BEA ARV Embouts Aluminium		
Retention particules	vide medical	
Classe de qualité - solides ⁽¹⁾	-	
Classe de qualité - Huile ⁽¹⁾	-	
Media Filtrant	-	
Température de fct.[°C]	1,5 à 65	
DP (élément neuf) [mbar]	-	

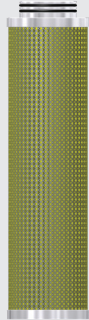
	DA-VAC	
	BEA	EVOAIR
ARV-100-DA	EBE ARV100 DA/VAC AL	
ARV-180-DA	EBE ARV180 DA/VAC AL	
ARV-290-DA	EBE ARV290 DA/VAC AL	
ARV-460-DA	EBE ARV460 DA/VAC AL	
ARV-610-DA	EBE ARV610 DA/VAC AL	
ARV-930-DA	EBE ARV930 DA/VAC AL	
ARV-1050-DA	EBE ARV1050 DA/VAC AL	
ARV-2300-DA	EBE ARV2300 DA/VAC AL	

BEA BST





	RM	RB	RA	CA
BEA BST Embouts Aluminium				
Retention particules	3 µm	0,1 µm	0,01 µm	charbon actif
Classe de qualité - solides ⁽¹⁾	6	2	1	1*
Classe de qualité - Huile ⁽¹⁾	-	2	1	1
Media Filtrant	fibres acrylique, cellulose	micro fibres de borosilicate		charbon actif
Température de fct. [°C]	1,5 à 65	1,5 à 65	1,5 à 65	1,5 à 45
DP (élément neuf) [mbar]	10	50	80	60

	RM		RB		RA		CA	
	BEA	EVOAIR	BEA	EVOAIR	BEA	EVOAIR	BEA	EVOAIR
BST-0032 RM	EBE BST 0032 RM/P AL	BST-0032 RB	EBE BST 0032 RB/M AL	BST-0032 RA	EBE BST 0032 RA/S AL	BST-0032 CA	EBE BST 0032 CA/A AL	
BST-0064 RM	EBE BST 0064 RM/P AL	BST-0064 RB	EBE BST 0064 RB/M AL	BST-0064 RA	EBE BST 0064 RA/S AL	BST-0064 CA	EBE BST 0064 CA/A AL	
BST-0105 RM	EBE BST 0105 RM/P AL	BST-0105 RB	EBE BST 0105 RB/M AL	BST-0105 RA	EBE BST 0105 RA/S AL	BST-0105 CA	EBE BST 0105 CA/A AL	
BST-0190 RM	EBE BST 0190 RM/P AL	BST-0190 RB	EBE BST 0190 RB/M AL	BST-0190 RA	EBE BST 0190 RA/S AL	BST-0190 CA	EBE BST 0190 CA/A AL	
BST-0300 RM	EBE BST 0300 RM/P AL	BST-0300 RB	EBE BST 0300 RB/M AL	BST-0300 RA	EBE BST 0300 RA/S AL	BST-0300 CA	EBE BST 0300 CA/A AL	
BST-0480 RM	EBE BST 0480 RM/P AL	BST-0480 RB	EBE BST 0480 RB/M AL	BST-0480 RA	EBE BST 0480 RA/S AL	BST-0480 CA	EBE BST 0480 CA/A AL	
BST-0700 RM	EBE BST 0700 RM/P AL	BST-0700 RB	EBE BST 0700 RB/M AL	BST-0700 RA	EBE BST 0700 RA/S AL	BST-0700 CA	EBE BST 0700 CA/A AL	
BST-1000 RM	EBE BST 1000 RM/P AL	BST-1000 RB	EBE BST 1000 RB/M AL	BST-1000 RA	EBE BST 1000 RA/S AL	BST-1000 CA	EBE BST 1000 CA/A AL	
BST-1200 RM	EBE BST 1200 RM/P AL	BST-1200 RB	EBE BST 1200 RB/M AL	BST-1200 RA	EBE BST 1200 RA/S AL	BST-1200 CA	EBE BST 1200 CA/A AL	
BST-1400 RM	EBE BST 1400 RM/P AL	BST-1400 RB	EBE BST 1400 RB/M AL	BST-1400 RA	EBE BST 1400 RA/S AL	BST-1400 CA	EBE BST 1400 CA/A AL	
BST-1500 RM	EBE BST 1500 RM/P AL	BST-1500 RB	EBE BST 1500 RB/M AL	BST-1500 RA	EBE BST 1500 RA/S AL	BST-1500 CA	EBE BST 1500 CA/A AL	
BST-2200 RM	EBE BST 2200 RM/P AL	BST-2200 RB	EBE BST 2200 RB/M AL	BST-2200 RA	EBE BST 2200 RA/S AL	BST-2200 CA	EBE BST 2200 CA/A AL	
BST-2300 RM	EBE BST 2300 RM/P AL	BST-2300 RB	EBE BST 2300 RB/M AL	BST-2300 RA	EBE BST 2300 RA/S AL	BST-2300 CA	EBE BST 2300 CA/A AL	

NOTE: * Valide si une cartouche filtrante "S" est installée en amont.

ELEMENTS FILTRANTS ALTERNATIFS



BEKO

	G	F	S	A
BEKO Embouts Plastique				
Retention particules	3 µm	0,1 µm	0,01 µm	charbon actif
Classe de qualité - solides ⁽¹⁾	6	2	1	1*
Classe de qualité - Huile ⁽¹⁾	-	2	1	1
Media Filtrant	fibres acrylique, cellulose		micro fibres de borosilicate	
Température de fct.[°C]	1,5 à 65	1,5 à 65	1,5 à 65	1,5 à 45
DP (élément neuf) [mbar]	10	50	80	60

	G		F		S		A	
	BEKO	EVOAIR	BEKO	EVOAIR	BEKO	EVOAIR	BEKO	EVOAIR
04 G	EBK 04 G/P	04 F	EBK 04 F/M	04 S	EBK 04 S/S	04 A	EBK 04 A/A	
05 G	EBK 05 G/P	05 F	EBK 05 F/M	05 S	EBK 05 S/S	05 A	EBK 05 A/A	
06 G	EBK 06 G/P	06 F	EBK 06 F/M	06 S	EBK 06 S/S	06 A	EBK 06 A/A	
07 G	EBK 07 G/P	07 F	EBK 07 F/M	07 S	EBK 07 S/S	07 A	EBK 07 A/A	
10 G	EBK 10 G/P	10 F	EBK 10 F/M	10 S	EBK 10 S/S	08 A	EBK 10 A/A	
12 G	EBK 12 G/P	12 F	EBK 12 F/M	12 S	EBK 12 S/S	10 A	EBK 12 A/A	
15 G	EBK 15 G/P	15 F	EBK 15 F/M	15 S	EBK 15 S/S	15 A	EBK 15 A/A	
18 G	EBK 18 G/P	18 F	EBK 18 F/M	18 S	EBK 18 S/S	18 A	EBK 18 A/A	
20 G	EBK 20 G/P	20 F	EBK 20 F/M	20 S	EBK 20 S/S	20 A	EBK 20 A/A	
22 G	EBK 22 G/P	22 F	EBK 22 F/M	22 S	EBK 22 S/S	22 A	EBK 22 A/A	
23 G	EBK 23 G/P	23 F	EBK 23 F/M	23 S	EBK 23 S/S	23 A	EBK 23 A/A	
25 G	EBK 25 G/P	25 F	EBK 25 F/M	25 S	EBK 25 S/S	25 A	EBK 25 A/A	
27 G	EBK 27 G/P	27 F	EBK 27 F/M	27 S	EBK 27 S/S	27 A	EBK 27 A/A	
30 G	EBK 30 G/P	30 F	EBK 30 F/M	30 S	EBK 30 S/S	30 A	EBK 30 A/A	
32 G	EBK 32 G/P	32 F	EBK 32 F/M	32 S	EBK 32 S/S	32 A	EBK 32 A/A	
88 G	EBK 88 G/P	88 F	EBK 88 F/M	88 S	EBK 88 S/S	88 A	EBK 88 A/A	

NOTE: * Valide si une cartouche filtrante "S" est installée en amont.

BOGE (nouveau)



	P	M	A
BOGE (nouveau) Embouts Plastique			
	3 µm	0,01 µm	charbon actif
Retention particules	3 µm	0,01 µm	charbon actif
Classe de qualité - solides ⁽¹⁾	6	1	1*
Classe de qualité - Huile ⁽¹⁾	-	1	1
Media Filtrant	fibres acrylique, cellulose	micro fibres de borosilicate	charbon actif
Température de fct. [°C]	1,5 à 65	1,5 à 65	1,5 à 45
DP (élément neuf) [mbar]	10	80	60

	P		M		A	
	BOGE	EVOAIR	BOGE	EVOAIR	BOGE	EVOAIR
F6P		EBO F6 P/R	F6M		F6A	EBO F6 A/A
F9P		EBO F9 P/R	F9M		F9A	EBO F9 A/A
F12P		EBO F12 P/R	F12M		F12A	EBO F12 A/A
F18P		EBO F18 P/R	F18M		F18A	EBO F18 A/A
F36P		EBO F36 P/R	F36M		F36A	EBO F36 A/A
F65P		EBO F65 P/R	F65M		F65A	EBO F65 A/A
F95P		EBO F95 P/R	F95M		F95A	EBO F95 A/A
F130P		EBO F130 P/R	F130M		F130A	EBO F130 A/A
F190P		EBO F190 P/R	F190M		F190A	EBO F190 A/A
F260P		EBO F260 P/R	F260M		F260A	EBO F260 A/A
F380P		EBO F380 P/R	F380M		F380A	EBO F380 A/A

NOTE: * Valide si une cartouche filtrante "S" est installée en amont.

ELEMENTS FILTRANTS ALTERNATIFS

BOGE (previous)

	V	FP	A
BOGE (previous) Embouts Plastique			
	3 µm	0,01 µm	charbon actif
Retention particules	3 µm	0,01 µm	charbon actif
Classe de qualité - solides ⁽¹⁾	6	1	1*
Classe de qualité - Huile ⁽¹⁾	-	1	1
Media Filtrant	fibres acrylique, cellulose	micro fibres de borosilicate	charbon actif
Température de fct. [°C]	1,5 à 65	1,5 à 65	1,5 à 45
DP (élément neuf) [mbar]	10	80	60





	V		FP		A	
	BOGE	EVOAIR	BOGE	EVOAIR	BOGE	EVOAIR
	1/5 V	EBO 5 V/P	1/5 FP	EBO 5 FP/S	1/5 A	EBO 5 A/A
	1/10 V	EBO 10 V/P	1/10 FP	EBO 10 FP/S	1/10 A	EBO 10 A/A
	1/12 V	EBO 12 V/P	1/12 FP	EBO 12 FP/S	1/12 A	EBO 12 A/A
	1/20 V	EBO 20 V/P	1/20 FP	EBO 20 FP/S	1/20 A	EBO 20 A/A
	1/30 V	EBO 30 V/P	1/30 FP	EBO 30 FP/S	1/30 A	EBO 30 A/A
	1/50 V	EBO 50 V/P	1/50 FP	EBO 50 FP/S	1/50 A	EBO 50 A/A
	1/80 V	EBO 80 V/P	1/80 FP	EBO 80 FP/S	1/80 A	EBO 80 A/A
	1/120 V	EBO 120 V/P	1/120 FP	EBO 120 FP/S	1/120 A	EBO 120 A/A
	1/160 V	EBO 160 V/P	1/160 FP	EBO 160 FP/S	1/160 A	EBO 160 A/A
	1/250 V	EBO 250 V/P	1/250 FP	EBO 250 FP/S	1/250 A	EBO 250 A/A

NOTE: * Valide si une cartouche filtrante "S" est installée en amont.

EVOAIR

Traitement de l'Air & des Gaz





CECCATO (nouveau)

	P	G	C	V
CECCATO (nouveau) Embouts Plastique				
	Retention particules	1 µm	0,1 µm	0,01 µm
Classe de qualité - solides ⁽¹⁾	3	2	1	1*
Classe de qualité - Huile ⁽¹⁾	-	2	1	1
Media Filtrant	micro fibres de borosilicate			charbon actif
Température de fct.[°C]	1,5 à 65	1,5 à 65	1,5 à 65	1,5 à 45
DP (élément neuf) [mbar]	20	50	80	60

	P		G		C		V	
	CECCATO	EVOAIR	CECCATO	EVOAIR	CECCATO	EVOAIR	CECCATO	EVOAIR
FILTER 7	ECE 7 P/R	FILTER 7	ECE 7 G/M	FILTER 7	ECE 7 C/S	FILTER 7	ECE 7 V/A	
FILTER 15	ECE 15 P/R	FILTER 15	ECE 15 G/M	FILTER 15	ECE 15 C/S	FILTER 15	ECE 15 V/A	
FILTER 21	ECE 21 P/R	FILTER 21	ECE 21 G/M	FILTER 21	ECE 21 C/S	FILTER 21	ECE 21 V/A	
FILTER 30	ECE 30 P/R	FILTER 30	ECE 30 G/M	FILTER 30	ECE 30 C/S	FILTER 30	ECE 30 V/A	
FILTER 48	ECE 48 P/R	FILTER 48	ECE 48 G/M	FILTER 48	ECE 48 C/S	FILTER 48	ECE 48 V/A	
FILTER 84	ECE 84 P/R	FILTER 84	ECE 84 G/M	FILTER 84	ECE 84 C/S	FILTER 84	ECE 84 V/A	
FILTER 114	ECE 114 P/R	FILTER 114	ECE 114 G/M	FILTER 114	ECE 114 C/S	FILTER 114	ECE 114 V/A	
FILTER 156	ECE 156 P/R	FILTER 156	ECE 156 G/M	FILTER 156	ECE 156 C/S	FILTER 156	ECE 156 V/A	
FILTER 216	ECE 216 P/R	FILTER 216	ECE 216 G/M	FILTER 216	ECE 216 C/S	FILTER 216	ECE 216 V/A	
FILTER 315	ECE 315 P/R	FILTER 315	ECE 315 G/M	FILTER 315	ECE 315 C/S	FILTER 315	ECE 315 V/A	
FILTER 405	ECE 405 P/R	FILTER 405	ECE 405 G/M	FILTER 405	ECE 405 C/S	FILTER 405	ECE 405 V/A	

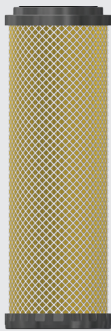
NOTE: * Valide si une cartouche filtrante "S" est installée en amont.





CECCATO (ancien)

	MBP	MBM	MBS	MBA
CECCATO (ancien) Embouts Plastique				
Retention particules	3 µm	0,1 µm	0,01 µm	charbon actif
Classe de qualité - solides ⁽¹⁾	6	2	1	1*
Classe de qualité - Huile ⁽¹⁾	-	2	1	1
Media Filtrant	fibres acrylique, cellulose	micro fibres de borosilicate		charbon actif
Température de fct. [°C]	1,5 à 65	1,5 à 65	1,5 à 65	1,5 à 45
DP (élément neuf) [mbar]	10	50	80	60

	MBP		MBM		MBS		MBA	
	CECCATO	EVOAIR	CECCATO	EVOAIR	CECCATO	EVOAIR	CECCATO	EVOAIR
MBP 10		ECE 10 MBP/P	MBM 10	ECE 10 MBM/M	MBS 10	ECE 10 MBS/S	MBA 10	ECE 10 MBA/A
MBP 13		ECE 13 MBP/P	MBM 13	ECE 13 MBM/M	MBS 13	ECE 13 MBS/S	MBA 13	ECE 13 MBA/A
MBP 20		ECE 20 MBP/P	MBM 20	ECE 20 MBM/M	MBS 20	ECE 20 MBS/S	MBA 20	ECE 20 MBA/A
MBP 33		ECE 33 MBP/P	MBM 33	ECE 33 MBM/M	MBS 33	ECE 33 MBS/S	MBA 33	ECE 33 MBA/A
MBP 60		ECE 60 MBP/P	MBM 60	ECE 60 MBM/M	MBS 60	ECE 60 MBS/S	MBA 60	ECE 60 MBA/A
MBP 85		ECE 85 MBP/P	MBM 85	ECE 85 MBM/M	MBS 85	ECE 85 MBS/S	MBA 85	ECE 85 MBA/A
MBP 130		ECE 130 MBP/P	MBM 130	ECE 130 MBM/M	MBS 130	ECE 130 MBS/S	MBA 130	ECE 130 MBA/A
MBP 170		ECE 170 MBP/P	MBM 170	ECE 170 MBM/M	MBS 170	ECE 170 MBS/S	MBA 170	ECE 170 MBA/A
MBP 250		ECE 250 MBP/P	MBM 250	ECE 250 MBM/M	MBS 250	ECE 250 MBS/S	MBA 250	ECE 250 MBA/A
MBP 400		ECE 400 MBP/P	MBM 400	ECE 400 MBM/M	MBS 400	ECE 400 MBS/S	MBA 400	ECE 400 MBA/A

NOTE: * Valide si une cartouche filtrante "S" est installée en amont.





CHICAGO PNEUMATIC (nouveau)

	P	G	C	V
CHICAGO PNEUMATIC (nouveau) Embouts Plastique				
	Retention particules	1 µm	0,1 µm	0,01 µm
Classe de qualité - solides ⁽¹⁾	3	2	1	1*
Classe de qualité - Huile ⁽¹⁾	-	2	1	1
Media Filtrant	micro fibres de borosilicate			charbon actif
Température de fct. [°C]	1,5 à 65	1,5 à 65	1,5 à 65	1,5 à 45
DP (élément neuf) [mbar]	20	50	80	60

	P		G		C		V	
	CHICAGO PNEUMATIC	EVOAIR	CHICAGO PNEUMATIC	EVOAIR	CHICAGO PNEUMATIC	EVOAIR	CHICAGO PNEUMATIC	EVOAIR
FILTER 45	ECP 45 P/R	FILTER 45	ECP 45 G/M	FILTER 45	ECP 45 C/S	FILTER 45	ECP 45 V/A	
FILTER 90	ECP 90 P/R	FILTER 90	ECP 90 G/M	FILTER 90	ECP 90 C/S	FILTER 90	ECP 90 V/A	
FILTER 125	ECP 125 P/R	FILTER 125	ECP 125 G/M	FILTER 125	ECP 125 C/S	FILTER 125	ECP 125 V/A	
FILTER 180	ECP 180 P/R	FILTER 180	ECP 180 G/M	FILTER 180	ECP 180 C/S	FILTER 180	ECP 180 V/A	
FILTER 290	ECP 290 P/R	FILTER 290	ECP 290 G/M	FILTER 290	ECP 290 C/S	FILTER 290	ECP 290 V/A	
FILTER 505	ECP 505 P/R	FILTER 505	ECP 505 G/M	FILTER 505	ECP 505 C/S	FILTER 505	ECP 505 V/A	
FILTER 685	ECP 685 P/R	FILTER 685	ECP 685 G/M	FILTER 685	ECP 685 C/S	FILTER 685	ECP 685 V/A	
FILTER 935	ECP 935 P/R	FILTER 935	ECP 935 G/M	FILTER 935	ECP 935 C/S	FILTER 935	ECP 935 V/A	
FILTER 1295	ECP 1295 P/R	FILTER 1295	ECP 1295 G/M	FILTER 1295	ECP 1295 C/S	FILTER 1295	ECP 1295 V/A	
FILTER 1890	ECP 1890 P/R	FILTER 1890	ECP 1890 G/M	FILTER 1890	ECP 1890 C/S	FILTER 1890	ECP 1890 V/A	
FILTER 2430	ECP 2430 P/R	FILTER 2430	ECP 2430 G/M	FILTER 2430	ECP 2430 C/S	FILTER 2430	ECP 2430 V/A	

NOTE: * Valide si une cartouche filtrante "S" est installée en amont.



CHICAGO PNEUMATIC (ancien)

	MBP	MBM	MBS	MBA
CHICAGO PNEUMATIC (ancien) Embouts Plastique				
	Retention particules	3 µm	0,1 µm	0,01 µm
Classe de qualité - solides ⁽¹⁾	6	2	1	1*
Classe de qualité - Huile ⁽¹⁾	-	2	1	1
Media Filtrant	fibres acrylique, cellulose	micro fibres de borosilicate		charbon actif
Température de fct. [°C]	1,5 à 65	1,5 à 65	1,5 à 65	1,5 à 45
DP (élément neuf) [mbar]	10	50	80	60

	MBP		MBM		MBS		MBA	
	CHICAGO PNEUMATIC	EVOAIR	CHICAGO PNEUMATIC	EVOAIR	CHICAGO PNEUMATIC	EVOAIR	CHICAGO PNEUMATIC	EVOAIR
MBP 60	ECP 60 MBP/P	MBM 60	ECP 60 MBM/M	MBS 60	ECP 60 MBS/S	MBA 60	ECP 60 MBA/A	
MBP 80	ECP 80 MBP/P	MBM 80	ECP 80 MBM/M	MBS 80	ECP 80 MBS/S	MBA 80	ECP 80 MBA/A	
MBP 120	ECP 120 MBP/P	MBM 120	ECP 120 MBM/M	MBS 120	ECP 120 MBS/S	MBA 120	ECP 120 MBA/A	
MBP 200	ECP 200 MBP/P	MBM 200	ECP 200 MBM/M	MBS 200	ECP 200 MBS/S	MBA 200	ECP 200 MBA/A	
MBP 340	ECP 340 MBP/P	MBM 340	ECP 340 MBM/M	MBS 340	ECP 340 MBS/S	MBA 340	ECP 340 MBA/A	
MBP 510	ECP 510 MBP/P	MBM 510	ECP 510 MBM/M	MBS 510	ECP 510 MBS/S	MBA 510	ECP 510 MBA/A	
MBP 800	ECP 800 MBP/P	MBM 800	ECP 800 MBM/M	MBS 800	ECP 800 MBS/S	MBA 800	ECP 800 MBA/A	
MBP 1000	ECP 1000 MBP/P	MBM 1000	ECP 1000 MBM/M	MBS 1000	ECP 1000 MBS/S	MBA 1000	ECP 1000 MBA/A	
MBP 1500	ECP 1500 MBP/P	MBM 1500	ECP 1500 MBM/M	MBS 1500	ECP 1500 MBS/S	MBA 1500	ECP 1500 MBA/A	
MBP 2400	ECP 2400 MBP/P	MBM 2400	ECP 2400 MBM/M	MBS 2400	ECP 2400 MBS/S	MBA 2400	ECP 2400 MBA/A	

NOTE: * Valide si une cartouche filtrante "S" est installée en amont.



COMPAIR

COMPAIR Embouts Plastique	B+E	C+F	D
			
Retention particules	1 µm	0,01 µm	charbon actif
Classe de qualité - solides ⁽¹⁾	3	1	1*
Classe de qualité - Huile ⁽¹⁾	-	1	1
Media Filtrant	micro fibres de borosilicate		charbon actif
Température de fct. [°C]	1,5 à 65	1,5 à 65	1,5 à 45
DP (élément neuf) [mbar]	20	80	60

COMPAIR	B+E		C+F		D	
	COMPAIR	EVOAIR	COMPAIR	EVOAIR	COMPAIR	EVOAIR
CE0006N B+E	ECO E 0006 B+E/R	CE0006N C+F	ECO E 0006 C+F/S	CE0006N D	ECO E 0006 D/A	
CE0012N B+E	ECO E 0012 B+E/R	CE0012N C+F	ECO E 0012 C+F/S	CE0012N D	ECO E 0012 D/A	
CE0018N B+E	ECO E 0018 B+E/R	CE0018N C+F	ECO E 0018 C+F/S	CE0018N D	ECO E 0018 D/A	
CE0036N B+E	ECO E 0036 B+E/R	CE0036N C+F	ECO E 0036 C+F/S	CE0036N D	ECO E 0036 D/A	
CE0066N B+E	ECO E 0066 B+E/R	CE0066N C+F	ECO E 0066 C+F/S	CE0066N D	ECO E 0066 D/A	
CE0096N B+E	ECO E 0096 B+E/R	CE0096N C+F	ECO E 0096 C+F/S	CE0096N D	ECO E 0096 D/A	
CE0132N B+E	ECO E 0132 B+E/R	CE0132N C+F	ECO E 0132 C+F/S	CE0132N D	ECO E 0132 D/A	
CE0198N B+E	ECO E 0198 B+E/R	CE0198N C+F	ECO E 0198 C+F/S	CE0198N D	ECO E 0198 D/A	
CE0258N B+E	ECO E 0258 B+E/R	CE0258N C+F	ECO E 0258 C+F/S	CE0258N D	ECO E 0258 D/A	
CE0372N B+E	ECO E 0372 B+E/R	CE0372N C+F	ECO E 0372 C+F/S	CE0372N D	ECO E 0372 D/A	
CE0600N B+E F	ECO E 0600F B+E/R	CE0600N C+F F	ECO E 0600F C+F/S	CE0600N D F	ECO E 0600F D/A	
CE0258N B+E F	ECO E 0258F B+E/R	CE0258N C+F F	ECO E 0258F C+F/S	CE0258N D F	ECO E 0258F D/A	
CE0372N B+E F	ECO E 0372F B+E/R	CE0372N C+F F	ECO E 0372F C+F/S	CE0372N D F	ECO E 0372F D/A	

NOTE: * Valide si une cartouche filtrante "S" est installée en amont.



CompAir (previous)

	B	C	D
COMPAIR (previous) Embouts Plastique			
	Retention particules	1 µm	0,01 µm
Classe de qualité - solides ⁽¹⁾	3	1	1*
Classe de qualité - Huile ⁽¹⁾	-	1	1
Media Filtrant	micro fibres de borosilicate		charbon actif
Température de fct. [°C]	1,5 à 65	1,5 à 65	1,5 à 45
DP (élément neuf) [mbar]	20	80	60

	B		C		D	
	COMPAIR	EVOAIR	COMPAIR	EVOAIR	COMPAIR	EVOAIR
CE0005 B	ECO 0005 B/R	CE0005 C	ECO 0005 C/S	CE0005 D	ECO 0005 D/A	
CE0010 B	ECO 0010 B/R	CE0010 C	ECO 0010 C/S	CE0010 D	ECO 0010 D/A	
CE0018 B	ECO 0018 B/R	CE0018 C	ECO 0018 C/S	CE0018 D	ECO 0018 D/A	
CE0036 B	ECO 0036 B/R	CE0036 C	ECO 0036 C/S	CE0036 D	ECO 0036 D/A	
CE0048 B CE0072 B CE0087 B	ECO 0048 B/R	CE0048 C CE0072 C CE0087 C	ECO 0048 C/S	CE0048 D CE0072 D CE0087 D	ECO 0048 D/A	
CE0120 B CE0132 B	ECO 0132 B/R	CE0120 C CE0132 C	ECO 0132 C/S	CE0120 D CE0132 D	ECO 0132 D/A	
CE0198 B	ECO 0198 B/R	CE0198 C	ECO 0198 C/S	CE0198 D	ECO 0198 D/A	
CE0240 B CE0258 B	ECO 0258 B/R	CE0240 C CE0258 C	ECO 0258 C/S	CE0240 D CE0258 D	ECO 0258 D/A	
CE0372 B	ECO 0372 B/R	CE0372 C	ECO 0372 C/S	CE0372 D	ECO 0372 D/A	

NOTE: * Valide si une cartouche filtrante "S" est installée en amont.





CompAir (previous)

	B	C	D
COMPAIR (previous) Embouts Aluminium			
	1 µm	0,01 µm	charbon actif
Retention particules	3	1	1*
Classe de qualité - solides ⁽¹⁾	-	1	1
Classe de qualité - Huile ⁽¹⁾	micro fibres de borosilicate		
Media Filtrant	1,5 à 65		charbon actif
Température de fct.[°C]	1,5 à 65		1,5 à 45
DP (élément neuf) [mbar]	20	80	60

	B		C		D	
	COMPAIR	EVOAIR	COMPAIR	EVOAIR	COMPAIR	EVOAIR
	CE0005 B	ECO 0005 B/R AL	CE0005 C	ECO 0005 C/S AL	CE0005 D	ECO 0005 D/A AL
	CE0010 B	ECO 0010 B/R AL	CE0010 C	ECO 0010 C/S AL	CE0010 D	ECO 0010 D/A AL
	CE0018 B	ECO 0018 B/R AL	CE0018 C	ECO 0018 C/S AL	CE0018 D	ECO 0018 D/A AL
	CE0036 B	ECO 0036 B/R AL	CE0036 C	ECO 0036 C/S AL	CE0036 D	ECO 0036 D/A AL
	CE0048 B CE0072 B CE0087 B	ECO 0048 B/R AL	CE0048 C CE0072 C CE0087 C	ECO 0048 C/S AL	CE0048 D CE0072 D CE0087 D	ECO 0048 D/A AL
	CE0120 B CE0132 B	ECO 0132 B/R AL	CE0120 C CE0132 C	ECO 0132 C/S AL	CE0120 D CE0132 D	ECO 0132 D/A AL
	CE0198 B	ECO 0198 B/R AL	CE0198 C	ECO 0198 C/S AL	CE0198 D	ECO 0198 D/A AL
	CE0240 B CE0258 B	ECO 0258 B/R AL	CE0240 C CE0258 C	ECO 0258 C/S AL	CE0240 D CE0258 D	ECO 0258 D/A AL
	CE0372 B	ECO 0372 B/R AL	CE0372 C	ECO 0372 C/S AL	CE0372 D	ECO 0372 D/A AL

NOTE: * Valide si une cartouche filtrante "S" est installée en amont.





DELTECH 300

	S3	P3	H3	C3
DELTECH 300 Embouts Plastique				
	Retention particules	3 µm	1 µm	0,01 µm
Classe de qualité - solides ⁽¹⁾	6	3	1	1*
Classe de qualité - Huile ⁽¹⁾	-	-	1	1
Media Filtrant	fibres acrylique, cellulose	micro fibres de borosilicate		charbon actif
Température de fct. [°C]	1,5 à 65	1,5 à 65	1,5 à 65	1,5 à 45
DP (élément neuf) [mbar]	10	20	80	60

	S3		P3		H3		C3	
	DELTECH	EVOAIR	DELTECH	EVOAIR	DELTECH	EVOAIR	DELTECH	EVOAIR
02-S3	EDT 300 02 S3/P	02-P3	EDT 300 02 P3/R	02-H3	EDT 300 02 H3/S	02-C3	EDT 300 02 C3/A	
03-S3	EDT 300 03 S3/P	03-P3	EDT 300 03 P3/R	03-H3	EDT 300 03 H3/S	03-C3	EDT 300 03 C3/A	
04-S3	EDT 300 04 S3/P	04-P3	EDT 300 04 P3/R	04-H3	EDT 300 04 H3/S	04-C3	EDT 300 04 C3/A	
06-S3	EDT 300 06 S3/P	06-P3	EDT 300 06 P3/R	06-H3	EDT 300 06 H3/S	06-C3	EDT 300 06 C3/A	
07-S3	EDT 300 07 S3/P	07-P3	EDT 300 07 P3/R	07-H3	EDT 300 07 H3/S	07-C3	EDT 300 07 C3/A	
08-S3	EDT 300 08 S3/P	08-P3	EDT 300 08 P3/R	08-H3	EDT 300 08 H3/S	08-C3	EDT 300 08 C3/A	
10-S3	EDT 300 10 S3/P	10-P3	EDT 300 10 P3/R	10-H3	EDT 300 10 H3/S	10-C3	EDT 300 10 C3/A	
11-S3	EDT 300 11 S3/P	11-P3	EDT 300 11 P3/R	11-H3	EDT 300 11 H3/S	11-C3	EDT 300 11 C3/A	
12-S3	EDT 300 12 S3/P	12-P3	EDT 300 12 P3/R	12-H3	EDT 300 12 H3/S	12-C3	EDT 300 12 C3/A	
13-S3	EDT 300 13 S3/P	13-P3	EDT 300 13 P3/R	13-H3	EDT 300 13 H3/S	13-C3	EDT 300 13 C3/A	
14-S3	EDT 300 14 S3/P	14-P3	EDT 300 14 P3/R	14-H3	EDT 300 14 H3/S	14-C3	EDT 300 14 C3/A	
15-S3	EDT 300 15 S3/P	15-P3	EDT 300 15 P3/R	15-H3	EDT 300 15 H3/S	15-C3	EDT 300 15 C3/A	
16-S3	EDT 300 16 S3/P	16-P3	EDT 300 16 P3/R	16-H3	EDT 300 16 H3/S	16-C3	EDT 300 16 C3/A	
17-S3	EDT 300 17 S3/P	17-P3	EDT 300 17 P3/R	17-H3	EDT 300 17 H3/S	17-C3	EDT 300 17 C3/A	

NOTE: * Valide si une cartouche filtrante "S" est installée en amont.





DELTECH

DELTECH Embouts Aluminium	DFD	PFD	HFD	CFD
				
Retention particules	1 µm	0,1 µm	0,01 µm	charbon actif
Classe de qualité - solides ⁽¹⁾	3	2	1	1*
Classe de qualité - Huile ⁽¹⁾	-	2	1	1
Media Filtrant	micro fibres de borosilicate			charbon actif
Température de fct. [°C]	1,5 à 65	1,5 à 65	1,5 à 65	1,5 à 45
DP (élément neuf) [mbar]	20	50	80	60

	DFD		PFD		HFD		CFD	
	DELTECH	EVOAIR	DELTECH	EVOAIR	DELTECH	EVOAIR	DELTECH	EVOAIR
DFD 9	EDT 9 DFD/R AL	PFD 9	EDT 9 PFD/M AL	HFD 9	EDT 9 HFD/S AL	CFD 9	EDT 9 CFD/A AL	
DFD 18	EDT 18 DFD/R AL	PFD 18	EDT 18 PFD/M AL	HFD 18	EDT 18 HFD/S AL	CFD 18	EDT 18 CFD/A AL	
DFD 36	EDT 36 DFD/R AL	PFD 36	EDT 36 PFD/M AL	HFD 36	EDT 36 HFD/S AL	CFD 36	EDT 36 CFD/A AL	
DFD 54	EDT 54 DFD/R AL	PFD 54	EDT 54 PFD/M AL	HFD 54	EDT 54 HFD/S AL	CFD 54	EDT 54 CFD/A AL	
DFD 90	EDT 90 DFD/R AL	PFD 90	EDT 90 PFD/M AL	HFD 90	EDT 90 HFD/S AL	CFD 90	EDT 90 CFD/A AL	
DFD 135	EDT 135 DFD/R AL	PFD 135	EDT 135 PFD/M AL	HFD 135	EDT 135 HFD/S AL	CFD 135	EDT 135 CFD/A AL	
DFD 216	EDT 216 DFD/R AL	PFD 216	EDT 216 PFD/M AL	HFD 216	EDT 216 HFD/S AL	CFD 216	EDT 216 CFD/A AL	
DFD 285	EDT 285 DFD/R AL	PFD 285	EDT 285 PFD/M AL	HFD 285	EDT 285 HFD/S AL	CFD 285	EDT 285 CFD/A AL	
DFD 405	EDT 405 DFD/R AL	PFD 405	EDT 405 PFD/M AL	HFD 405	EDT 405 HFD/S AL	CFD 405	EDT 405 CFD/A AL	
DFD 540	EDT 540 DFD/R AL	PFD 540	EDT 540 PFD/M AL	HFD 540	EDT 540 HFD/S AL	CFD 540	EDT 540 CFD/A AL	
DFD 750	EDT 750 DFD/R AL	PFD 750	EDT 750 PFD/M AL	HFD 750	EDT 750 HFD/S AL	CFD 750	EDT 750 CFD/A AL	
DFD 8113	EDT 8113 DFD/R AL	PFD 8113	EDT 8113 PFD/M AL	HFD 8113	EDT 8113 HFD/S AL	CFD 8113	EDT 8113 CFD/A AL	
DFDL 8113	EDT 8113L DFD/R AL	PFDL 8113	EDT 8113L PFD/M AL	HFDL 8113	EDT 8113L HFD/S AL	CFDL 8113	EDT 8113L CFD/A AL	

NOTE: * Valide si une cartouche filtrante "S" est installée en amont.



DOMNICK HUNTER - oil-x evolution

	AR	AO	AA	ACS	MV
DOMNICK HUNTER Embouts Plastique					
	Retention particules	1 µm	0,1 µm	0,01 µm	charbon actif
Classe de qualité - solides ⁽¹⁾	3	2	1	1*	-
Classe de qualité - Huile ⁽¹⁾	-	2	1	1	-
Media Filtrant	micro fibres de borosilicate			charbon actif	
Température de fct.[°C]	1,5 à 65	1,5 à 65	1,5 à 65	1,5 à 45	1,5 à 65
DP (élément neuf) [mbar]	20	50	80	60	-

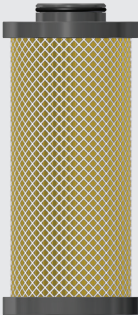

	AR		AO		AA		ACS		MV	
	DOMNICK HUNTER	EVOAIR	DOMNICK HUNTER	EVOAIR	DOMNICK HUNTER	EVOAIR	DOMNICK HUNTER	EVOAIR	DOMNICK HUNTER	EVOAIR
005 AR	EDHE 005 AR/R	005 AO	EDHE 005 AO/M	005 AA	EDHE 005 AA/S	005 ACS	EDHE 005 ACS/A			
010 AR	EDHE 010 AR/R	010 AO	EDHE 010 AO/M	010 AA	EDHE 010 AA/S	010 ACS	EDHE 010 ACS/A	010 MV	EDHE 010 MV/MV	
015 AR	EDHE 015 AR/R	015 AO	EDHE 015 AO/M	015 AA	EDHE 015 AA/S	015 ACS	EDHE 015 ACS/A	015 MV	EDHE 015 MV/MV	
020 AR	EDHE 020 AR/R	020 AO	EDHE 020 AO/M	020 AA	EDHE 020 AA/S	020 ACS	EDHE 020 ACS/A	020 MV	EDHE 020 MV/MV	
025 AR	EDHE 025 AR/R	025 AO	EDHE 025 AO/M	025 AA	EDHE 025 AA/S	025 ACS	EDHE 025 ACS/A	025 MV	EDHE 025 MV/MV	
030 AR	EDHE 030 AR/R	030 AO	EDHE 030 AO/M	030 AA	EDHE 030 AA/S	030 ACS	EDHE 030 ACS/A	030 MV	EDHE 030 MV/MV	
035 AR	EDHE 035 AR/R	035 AO	EDHE 035 AO/M	035 AA	EDHE 035 AA/S	035 ACS	EDHE 035 ACS/A	035 MV	EDHE 035 MV/MV	
040 AR	EDHE 040 AR/R	040 AO	EDHE 040 AO/M	040 AA	EDHE 040 AA/S	040 ACS	EDHE 040 ACS/A	040 MV	EDHE 040 MV/MV	
045 AR	EDHE 045 AR/R	045 AO	EDHE 045 AO/M	045 AA	EDHE 045 AA/S	045 ACS	EDHE 045 ACS/A	045 MV	EDHE 045 MV/MV	
050 AR	EDHE 050 AR/R	050 AO	EDHE 050 AO/M	050 AA	EDHE 050 AA/S	050 ACS	EDHE 050 ACS/A	050 MV	EDHE 050 MV/MV	
055 AR	EDHE 055 AR/R	055 AO	EDHE 055 AO/M	055 AA	EDHE 055 AA/S	055 ACS	EDHE 055 ACS/A	055 MV	EDHE 055 MV/MV	
060 AR	EDHE 060 AR/R	060 AO	EDHE 060 AO/M	060 AA	EDHE 060 AA/S	060 ACS	EDHE 060 ACS/A			
150 AR	EDHE 150 AR/R	150 AO	EDHE 150 AO/M	150 AA	EDHE 150 AA/S	150 ACS	EDHE 150 ACS/A			
200 AR	EDHE 200 AR/R	200 AO	EDHE 200 AO/M	200 AA	EDHE 200 AA/S	200 ACS	EDHE 200 ACS/A			

NOTE: * Valide si une cartouche filtrante "S" est installée en amont.

DOMNICK HUNTER - oil-x plus

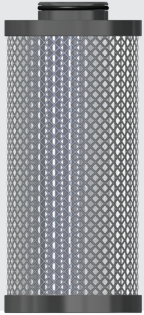

DOMNICK HUNTER Embouts Plastique	PF	AO
		
Retention particules	3 µm	0,1 µm
Classe de qualité - solides ⁽¹⁾	6	2
Classe de qualité - Huile ⁽¹⁾	-	2
Media Filtrant	fibres acrylique, cellulose	micro fibres de borosilicate
Température de fct.[°C]	1,5 à 65	1,5 à 65
DP (élément neuf) [mbar]	10	50

	PF				AO			
	DOMNICK HUNTER			EVOAIR	DOMNICK HUNTER			EVOAIR
	Oil-x plus	Oil-x	Oil-x 80		Oil-x plus	Oil-x	Oil-x 80	
	K 009 PF	K 006 PF	/	EDH 009 PF/P	K 009 AO	K 006 AO	/	EDH 009 AO/M
	K 017 PF	K 013 PF	E 007 PF	EDH 017 PF/P	K 017 AO	K 013 AO	E 007 AO	EDH 017 AO/M
	K 030 PF	K 025 PF	E 011 PF	EDH 030 PF/P	K 030 AO	K 025 AO	E 011 AO	EDH 030 AO/M
	K 058 PF	K 040 PF	E 035 PF	EDH 058 PF/P	K 058 AO	K 040 AO	E 035 AO	EDH 058 AO/M
	K 145 PF	K 085 PF	E 65 PF / E 060 PF	EDH 145 PF/P	K 145 AO	K 085 AO	E 65 AO / E 060 AO	EDH 145 AO/M
	K 220 PF	K 195 PF	E 120 PF	EDH 220 PF/P	K 220 AO	K 195 AO	E 120 AO	EDH 220 AO/M
	K 330 PF	K 295 PF	E 250 PF / E 200 PF	EDH 330 PF/P	K 330 AO	K 295 AO	E 250 AO / E 200 AO	EDH 330 AO/M
	K 430 PF	K 400 PF	N/A	EDH 430 PF/P	K 430 AO	K 400 AO	N/A	EDH 430 AO/M
	K 620 PF	K 500 PF	E 360 PF / E 300 PF	EDH 620 PF/P	K 620 AO	K 500 AO	E 360 AO / E 300 AO	EDH 620 AO/M



DOMNICK HUNTER Embouts Plastique	AA	ACS	MV
			
Retention particules	0,01 µm	charbon actif	medical vacuum
Classe de qualité - solides ⁽¹⁾	1	1*	-
Classe de qualité - Huile ⁽¹⁾	1	1	-
Media Filtrant	micro fibres de borosilicate	charbon actif	-
Température de fct.[°C]	1,5 à 65	1,5 à 45	1,5 à 65
DP (élément neuf) [mbar]	80	60	-

DOMNICK HUNTER	AA			EVOAIR		ACS		EVOAIR		MV		EVOAIR	
	DOMNICK HUNTER			EVOAIR	DOMNICK HUNTER		EVOAIR	DOMNICK HUNTER		EVOAIR	DOMNICK HUNTER		EVOAIR
	Oil-x plus	Oil-x	Oil-x 80		Oil-x plus	Oil-x plus		Oil-x plus	Oil-x plus				
K 009 AA	K 006 AA	/	EDH 009 AA/S	K 009 ACS	EDH 009 ACS/A	K 009 MV	EDH 009 MV/MV						
K 017 AA	K 013 AA	E 007 AA	EDH 017 AA/S	K 017 ACS	EDH 017 ACS/A	K 017 MV	EDH 017 MV/MV						
K 030 AA	K 025 AA	E 011 AA	EDH 030 AA/S	K 030 ACS	EDH 030 ACS/A	K 030 MV	EDH 030 MV/MV						
K 058 AA	K 040 AA	E 035 AA	EDH 058 AA/S	K 058 ACS	EDH 058 ACS/A	K 058 MV	EDH 058 MV/MV						
K 145 AA	K 085 AA	E 65 AA / E 060 AA	EDH 145 AA/S	K 145 ACS	EDH 145 ACS/A	K 145 MV	EDH 145 MV/MV						
K 220 AA	K 195 AA	E 120 AA	EDH 220 AA/S	K 220 ACS	EDH 220 ACS/A	K 220 MV	EDH 220 MV/MV						
K 330 AA	K 295 AA	E 250 AA / E 200 AA	EDH 330 AA/S	K 330 ACS	EDH 330 ACS/A	K 330 MV	EDH 330 MV/MV						
K 430 AA	K 400 AA	N/A	EDH 430 AA/S	K 430 ACS	EDH 430 ACS/A	K 430 MV	EDH 430 MV/MV						
K 620 AA	K 500 AA	E 360 AA / E 300 AA	EDH 620 AA/S	K 620 ACS	EDH 620 ACS/A	K 620 MV	EDH 620 MV/MV						

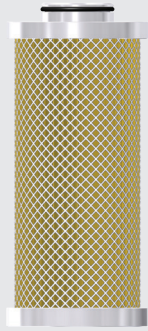

NOTE: * Valide si une cartouche filtrante "S" est installée en amont.

DOMNICK HUNTER Embouts Plastique	AC	HC		
				
Retention particules	0,1 µm	0,1 µm		
Classe de qualité - solides ⁽¹⁾	1*	1*		
Classe de qualité - Huile ⁽¹⁾	0/1	-		
Media Filtrant	charbon actif, micro fibres de borosilicate	Hopcalite, micro fibres de borosilicate		
Température de fct.[°C]	1,5 à 45	1,5 à 45		
DOMNICK HUNTER	AC		HC	
	DOMNICK HUNTER	EVOAIR	DOMNICK HUNTER	EVOAIR
	Oil-x plus	Oil-x plus	Oil-x plus	Oil-x plus
	K 006 AC	EDH 006 AC/A2	K 006 HC	EDH 006 HC/H2
	K 013 AC	EDH 013 AC/A2	K 013 HC	EDH 013 HC/H2
	K 025 AC	EDH 025 AC/A	-	-
	K 040 AC	EDH 040 AC/A2	K 040 HC	EDH 040 HC/H2
K 065 AC	EDH 065 AC/A	-	-	
K 085 AC	EDH 085 AC/A	-	-	

DOMNICK HUNTER - oil-x plus

	PF	AO
DOMNICK HUNTER Embouts Aluminium		
	3 µm	0,1 µm
Retention particules	3 µm	0,1 µm
Classe de qualité - solides ⁽¹⁾	6	2
Classe de qualité - Huile ⁽¹⁾	-	2
Media Filtrant	fibres acrylique, cellulose	micro fibres de borosilicate
Température de fct.[°C]	1,5 à 65	1,5 à 65
DP (élément neuf) [mbar]	10	50

	PF				AO			
	DOMNICK HUNTER			EVOAIR	DOMNICK HUNTER			EVOAIR
	Oil-x plus	Oil-x	Oil-x 80		Oil-x plus	Oil-x	Oil-x 80	
	K 009 PF	K 006 PF	/	EDH 009 PF/P AL	K 009 AO	K 006 AO	/	EDH 009 AO/M AL
	K 017 PF	K 013 PF	E 007 PF	EDH 017 PF/P AL	K 017 AO	K 013 AO	E 007 AO	EDH 017 AO/M AL
	K 030 PF	K 025 PF	E 011 PF	EDH 030 PF/P AL	K 030 AO	K 025 AO	E 011 AO	EDH 030 AO/M AL
	K 058 PF	K 040 PF	E 035 PF	EDH 058 PF/P AL	K 058 AO	K 040 AO	E 035 AO	EDH 058 AO/M AL
	K 145 PF	K 085 PF	E 65 PF / E 060 PF	EDH 145 PF/P AL	K 145 AO	K 085 AO	E 65 AO / E 060 AO	EDH 145 AO/M AL
	K 220 PF	K 195 PF	E 120 PF	EDH 220 PF/P AL	K 220 AO	K 195 AO	E 120 AO	EDH 220 AO/M AL
	K 330 PF	K 295 PF	E 250 PF / E 200 PF	EDH 330 PF/P AL	K 330 AO	K 295 AO	E 250 AO / E 200 AO	EDH 330 AO/M AL
	K 430 PF	K 400 PF	N/A	EDH 430 PF/P AL	K 430 AO	K 400 AO	N/A	EDH 430 AO/M AL
	K 620 PF	K 500 PF	E 360 PF / E 300 PF	EDH 620 PF/P AL	K 620 AO	K 500 AO	E 360 AO / E 300 AO	EDH 620 AO/M AL



	AA	ACS
DOMNICK HUNTER Embouts Aluminium		
	0,01 µm	charbon actif
Retention particules	0,01 µm	charbon actif
Classe de qualité - solides ⁽¹⁾	1	1*
Classe de qualité - Huile ⁽¹⁾	1	1
Media Filtrant	micro fibres de borosilicate	charbon actif
Température de fct. [°C]	1,5 à 65	1,5 à 45
DP (élément neuf) [mbar]	80	60

AA				ACS	
DOMNICK HUNTER			EVOAIR	DOMNICK HUNTER	
Oil-x plus	Oil-x	Oil-x 80		Oil-x plus	EVOAIR
K 009 AA	K 006 AA	/	EDH 009 AA/S AL	K 009 ACS	EDH 009 ACS/A AL
K 017 AA	K 013 AA	E 007 AA	EDH 017 AA/S AL	K 017 ACS	EDH 017 ACS/A AL
K 030 AA	K 025 AA	E 011 AA	EDH 030 AA/S AL	K 030 ACS	EDH 030 ACS/A AL
K 058 AA	K 040 AA	E 035 AA	EDH 058 AA/S AL	K 058 ACS	EDH 058 ACS/A AL
K 145 AA	K 085 AA	E 65 AA / E 060 AA	EDH 145 AA/S AL	K 145 ACS	EDH 145 ACS/A AL
K 220 AA	K 195 AA	E 120 AA	EDH 220 AA/S AL	K 220 ACS	EDH 220 ACS/A AL
K 330 AA	K 295 AA	E 250 AA / E 200 AA	EDH 330 AA/S AL	K 330 ACS	EDH 330 ACS/A AL
K 430 AA	K 400 AA	N/A	EDH 430 AA/S AL	K 430 ACS	EDH 430 ACS/A AL
K 620 AA	K 500 AA	E 360 AA / E 300 AA	EDH 620 AA/S AL	K 620 ACS	EDH 620 ACS/A AL

NOTE: * Valide si une cartouche filtrante "S" est installée en amont.

ELEMENTS FILTRANTS
ALTERNATIFS



DOMNICK HUNTER HT

	AO	AA
		
DOMNICK HUNTER		
Embouts Aluminium		
Retention particules	0,1 µm	0,01 µm
Classe de qualité - solides ⁽¹⁾	2	1
Classe de qualité - Huile ⁽¹⁾	2	1
Media Filtrant	micro fibres de borosilicate	
Température de fct.[°C]	1,5 à 65	1,5 à 65
DP (élément neuf) [mbar]	50	80

	AO		AA		
	DOMNICK HUNTER	EVOAIR	DOMNICK HUNTER	EVOAIR	
K009 AO TS	EDH 009 AO/M HT AL	K009 AO TS	EDH 009 AO/S HT AL	K009 AA TS	EDH 009 AA/S HT AL
K017 AO TS	EDH 017 AO/M HT AL	K017 AO TS	EDH 017 AO/S HT AL	K017 AA TS	EDH 017 AA/S HT AL
K030 AO TS	EDH 030 AO/M HT AL	K030 AO TS	EDH 030 AO/S HT AL	K030 AA TS	EDH 030 AA/S HT AL
K058 AO TS	EDH 058 AO/M HT AL	K058 AO TS	EDH 058 AO/S HT AL	K058 AA TS	EDH 058 AA/S HT AL
K145 AO TS	EDH 145 AO/M HT AL	K145 AO TS	EDH 145 AO/S HT AL	K145 AA TS	EDH 145 AA/S HT AL
K220 AO TS	EDH 220 AO/M HT AL	K220 AO TS	EDH 220 AO/S HT AL	K220 AA TS	EDH 220 AA/S HT AL
K330 AO TS	EDH 330 AO/M HT AL	K330 AO TS	EDH 330 AO/S HT AL	K330 AA TS	EDH 330 AA/S HT AL
K430 AO TS	EDH 430 AO/M HT AL	K430 AO TS	EDH 430 AO/S HT AL	K430 AA TS	EDH 430 AA/S HT AL
K620 AO TS	EDH 620 AO/M HT AL	K620 AO TS	EDH 620 AO/S HT AL	K620 AA TS	EDH 620 AA/S HT AL

NOTE: * Valide si une cartouche filtrante "S" est installée en amont.

DOMNICK HUNTER NH3





	AO	AA
	DOMNICK HUNTER Embouts Aluminium  	
Retention particules	0,1 µm	0,01 µm
Classe de qualité - solides ⁽¹⁾	2	1
Classe de qualité - Huile ⁽¹⁾	2	1
Media Filtrant	micro fibres de borosilicate	
Température de fct.[°C]	1,5 à 65	1,5 à 65
DP (élément neuf) [mbar]	50	80

	AO		AA	
	DOMNICK HUNTER	EVOAIR	DOMNICK HUNTER	EVOAIR
E120AO NH3	EDH 220 AO/M NH3 AL	E120AA NH3	EDH 220 AA/S NH3 AL	
E250AO NH3	EDH 330 AO/M NH3 AL	E250AA NH3	EDH 330 AA/S NH3 AL	
E360AO NH3	EDH 620 AO/M NH3 AL	E360AA NH3	EDH 620 AA/S NH3 AL	

NOTE: * Valide si une cartouche filtrante "S" est installée en amont.

evoair ELEMENTS FILTRANTS
AIR COMPRIMÉ ALTERNATIFS

DONALDSON DF

	P	V	M	S	A
DONALDSON DF Embouts Plastique					
	3 µm	1 µm	0,1 µm	0,01 µm	charbon actif
Retention particules	3 µm	1 µm	0,1 µm	0,01 µm	charbon actif
Classe de qualité - solides ⁽¹⁾	6	3	2	1	1*
Classe de qualité - Huile ⁽¹⁾	-	-	2	1	1
Media Filtrant	fibres acrylique, cellulose		micro fibres de borosilicate		charbon actif
Température de fct.[°C]	1,5 à 65	1,5 à 65	1,5 à 65	1,5 à 65	1,5 à 45
DP (élément neuf) [mbar]	10	20	50	80	60



	P		V		M		S		A	
	DONALDSON	EVOAIR	DONALDSON	EVOAIR	DONALDSON	EVOAIR	DONALDSON	EVOAIR	DONALDSON	EVOAIR
DF P 0035	EDO DF 0035 P/P	DF V 0035	EDO DF 0035 V/R	DF M 0035	EDO DF 0035 M/M	DF S 0035	EDO DF 0035 S/S	DF A 0035	EDO DF 0035 A/A	
DF P 0070	EDO DF 0070 P/P	DF V 0070	EDO DF 0070 V/R	DF M 0070	EDO DF 0070 M/M	DF S 0070	EDO DF 0070 S/S	DF A 0070	EDO DF 0070 A/A	
DF P 0120	EDO DF 0120 P/P	DF V 0120	EDO DF 0120 V/R	DF M 0120	EDO DF 0120 M/M	DF S 0120	EDO DF 0120 S/S	DF A 0120	EDO DF 0120 A/A	
DF P 0210	EDO DF 0210 P/P	DF V 0210	EDO DF 0210 V/R	DF M 0210	EDO DF 0210 M/M	DF S 0210	EDO DF 0210 S/S	DF A 0210	EDO DF 0210 A/A	
DF P 0320	EDO DF 0320 P/P	DF V 0320	EDO DF 0320 V/R	DF M 0320	EDO DF 0320 M/M	DF S 0320	EDO DF 0320 S/S	DF A 0320	EDO DF 0320 A/A	
DF P 0450	EDO DF 0450 P/P	DF V 0450	EDO DF 0450 V/R	DF M 0450	EDO DF 0450 M/M	DF S 0450	EDO DF 0450 S/S	DF A 0450	EDO DF 0450 A/A	
DF P 0600	EDO DF 0600 P/P	DF V 0600	EDO DF 0600 V/R	DF M 0600	EDO DF 0600 M/M	DF S 0600	EDO DF 0600 S/S	DF A 0600	EDO DF 0600 A/A	
DF P 0750	EDO DF 0750 P/P	DF V 0750	EDO DF 0750 V/R	DF M 0750	EDO DF 0750 M/M	DF S 0750	EDO DF 0750 S/S	DF A 0750	EDO DF 0750 A/A	
DF P 1100	EDO DF 1100 P/P	DF V 1100	EDO DF 1100 V/R	DF M 1100	EDO DF 1100 M/M	DF S 1100	EDO DF 1100 S/S	DF A 1100	EDO DF 1100 A/A	

NOTE: * Valide si une cartouche filtrante "S" est installée en amont.

EVOAIR



Traitement de l'Air & des Gaz

DONALDSON serie '90

	SB	PE	PE	FF
DONALDSON SERIES '90 Embouts Plastique				
	Retention particules	25 µm	25 µm	3 µm
Classe de qualité - solides ⁽¹⁾	-	-	6	2
Classe de qualité - Huile ⁽¹⁾	-	-	-	2
Media Filtrant	Laiton fritté	Polyéthilene fritté	fibres acrylique, cellulose	micro fibres de borosilicate
Température de fct.[°C]	1,5 à 65	1,5 à 65	1,5 à 65	1,5 à 65
DP (élément neuf) [mbar]	20	10	10	50

	SB		PE		PE		FF	
	DONALDSON	EVOAIR	DONALDSON	EVOAIR	DONALDSON	EVOAIR	DONALDSON	EVOAIR
	SB 02/05	EDO 0205 SB	PE 02/05	EDO 0205 PE	PE 02/05	EDO 0205 PE/P	FF 02/05	EDO 0205 FF
	/	EDO 0210 SB	/	EDO 0210 PE	/	EDO 0210 PE/P	/	EDO 0210 FF
	SB 03/05	EDO 0305 SB	PE 03/05	EDO 0305 PE	PE 03/05	EDO 0305 PE/P	FF 03/05	EDO 0305 FF
	SB 03/10	EDO 0310 SB	PE 03/10	EDO 0310 PE	PE 03/10	EDO 0310 PE/P	FF 03/10	EDO 0310 FF
	SB 04/10	EDO 0410 SB	PE 04/10	EDO 0410 PE	PE 04/10	EDO 0410 PE/P	FF 04/10	EDO 0410 FF
	SB 04/20	EDO 0420 SB	PE 04/20	EDO 0420 PE	PE 04/20	EDO 0420 PE/P	FF 04/20	EDO 0420 FF
	SB 05/20	EDO 0520 SB	PE 05/20	EDO 0520 PE	PE 05/20	EDO 0520 PE/P	FF 05/20	EDO 0520 FF
	SB 05/25	EDO 0525 SB	PE 05/25	EDO 0525 PE	PE 05/25	EDO 0525 PE/P	FF 05/25	EDO 0525 FF
	SB 07/25	EDO 0725 SB	PE 07/25	EDO 0725 PE	PE 07/25	EDO 0725 PE/P	FF 07/25	EDO 0725 FF
	SB 07/30	EDO 0730 SB	PE 07/30	EDO 0730 PE	PE 07/30	EDO 0730 PE/P	FF 07/30	EDO 0730 FF
	SB 10/30	EDO 1030 SB	PE 10/30	EDO 1030 PE	PE 10/30	EDO 1030 PE/P	FF 10/30	EDO 1030 FF
	SB 15/30	EDO 1530 SB	PE 15/30	EDO 1530 PE	PE 15/30	EDO 1530 PE/P	FF 15/30	EDO 1530 FF
	SB 20/30	EDO 2030 SB	PE 20/30	EDO 2030 PE	PE 20/30	EDO 2030 PE/P	FF 20/30	EDO 2030 FF
	SB 30/30	EDO 3030 SB	PE 30/30	EDO 3030 PE	PE 30/30	EDO 3030 PE/P	FF 30/30	EDO 3030 FF
	SB 30/50	EDO 3050 SB	PE 30/50	EDO 3050 PE	PE 30/50	EDO 3050 PE/P	FF 30/50	EDO 3050 FF

NOTE: * Valide si une cartouche filtrante "S" est installée en amont.

MF	SMF	AK
		
0,1 µm	0,01 µm	charbon actif
2	1	1*
1	1	1
		charbon actif
1,5 à 65	1,5 à 65	1,5 à 45
70	80	60



MF		SMF		AK	
DONALDSON	EVOAIR	DONALDSON	EVOAIR	DONALDSON	EVOAIR
MF 02/05	EDO 0205 MF	SMF 02/05	EDO 0205 SMF	AK 02/05	EDO 0205 AK/A
/	EDO 0210 MF	/	EDO 0210 SMF	/	EDO 0210 AK/A
MF 03/05	EDO 0305 MF	SMF 03/05	EDO 0305 SMF	AK 03/05	EDO 0305 AK/A
MF 03/10	EDO 0310 MF	SMF 03/10	EDO 0310 SMF	AK 03/10	EDO 0310 AK/A
MF 04/10	EDO 0410 MF	SMF 04/10	EDO 0410 SMF	AK 04/10	EDO 0410 AK/A
MF 04/20	EDO 0420 MF	SMF 04/20	EDO 0420 SMF	AK 04/20	EDO 0420 AK/A
MF 05/20	EDO 0520 MF	SMF 05/20	EDO 0520 SMF	AK 05/20	EDO 0520 AK/A
MF 05/25	EDO 0525 MF	SMF 05/25	EDO 0525 SMF	AK 05/25	EDO 0525 AK/A
MF 07/25	EDO 0725 MF	SMF 07/25	EDO 0725 SMF	AK 07/25	EDO 0725 AK/A
MF 07/30	EDO 0730 MF	SMF 07/30	EDO 0730 SMF	AK 07/30	EDO 0730 AK/A
MF 10/30	EDO 1030 MF	SMF 10/30	EDO 1030 SMF	AK 10/30	EDO 1030 AK/A
MF 15/30	EDO 1530 MF	SMF 15/30	EDO 1530 SMF	AK 15/30	EDO 1530 AK/A
MF 20/30	EDO 2030 MF	SMF 20/30	EDO 2030 SMF	AK 20/30	EDO 2030 AK/A
MF 30/30	EDO 3030 MF	SMF 30/30	EDO 3030 SMF	AK 30/30	EDO 3030 AK/A
MF 30/50	EDO 3050 MF	SMF 30/50	EDO 3050 SMF	AK 30/50	EDO 3050 AK/A

DONALDSON '90 series

DONALDSON '90 SERIES Embouts Aluminium	SB	PE	PE	FF
				
Retention particules	25 µm	25 µm	3 µm	0,1 µm
Classe de qualité - solides ⁽¹⁾	-	-	6	2
Classe de qualité - Huile ⁽¹⁾	-	-	-	2
Media Filtrant	Laiton fritté	Polyéthilene fritté	fibres acrylique, cellulose	micro fibres de borosilicate
Température de fct. [°C]	1,5 à 65	1,5 à 65	1,5 à 65	1,5 à 65
DP (élément neuf) [mbar]	20	10	10	50



	SB		PE		PE		FF	
	DONALDSON	EVOAIR	DONALDSON	EVOAIR	DONALDSON	EVOAIR	DONALDSON	EVOAIR
	SB 02/05	EDO 0205 SB AL	PE 02/05	EDO 0205 PE AL	PE 02/05	EDO 0205 PE/P AL	FF 02/05	EDO 0205 FF AL
	/	EDO 0210 SB AL	/	EDO 0210 PE AL	/	EDO 0210 PE/P AL	/	EDO 0210 FF AL
	SB 03/05	EDO 0305 SB AL	PE 03/05	EDO 0305 PE AL	PE 03/05	EDO 0305 PE/P AL	FF 03/05	EDO 0305 FF AL
	SB 03/10	EDO 0310 SB AL	PE 03/10	EDO 0310 PE AL	PE 03/10	EDO 0310 PE/P AL	FF 03/10	EDO 0310 FF AL
	SB 04/10	EDO 0410 SB AL	PE 04/10	EDO 0410 PE AL	PE 04/10	EDO 0410 PE/P AL	FF 04/10	EDO 0410 FF AL
	SB 04/20	EDO 0420 SB AL	PE 04/20	EDO 0420 PE AL	PE 04/20	EDO 0420 PE/P AL	FF 04/20	EDO 0420 FF AL
	SB 05/20	EDO 0520 SB AL	PE 05/20	EDO 0520 PE AL	PE 05/20	EDO 0520 PE/P AL	FF 05/20	EDO 0520 FF AL
	SB 05/25	EDO 0525 SB AL	PE 05/25	EDO 0525 PE AL	PE 05/25	EDO 0525 PE/P AL	FF 05/25	EDO 0525 FF AL
	SB 07/25	EDO 0725 SB AL	PE 07/25	EDO 0725 PE AL	PE 07/25	EDO 0725 PE/P AL	FF 07/25	EDO 0725 FF AL
	SB 07/30	EDO 0730 SB AL	PE 07/30	EDO 0730 PE AL	PE 07/30	EDO 0730 PE/P AL	FF 07/30	EDO 0730 FF AL
	SB 10/30	EDO 1030 SB AL	PE 10/30	EDO 1030 PE AL	PE 10/30	EDO 1030 PE/P AL	FF 10/30	EDO 1030 FF AL
	SB 15/30	EDO 1530 SB AL	PE 15/30	EDO 1530 PE AL	PE 15/30	EDO 1530 PE/P AL	FF 15/30	EDO 1530 FF AL
	SB 20/30	EDO 2030 SB AL	PE 20/30	EDO 2030 PE AL	PE 20/30	EDO 2030 PE/P AL	FF 20/30	EDO 2030 FF AL
	SB 30/30	EDO 3030 SB AL	PE 30/30	EDO 3030 PE AL	PE 30/30	EDO 3030 PE/P AL	FF 30/30	EDO 3030 FF AL
	SB 30/50	EDO 3050 SB AL	PE 30/50	EDO 3050 PE AL	PE 30/50	EDO 3050 PE/P AL	FF 30/50	EDO 3050 FF AL

NOTE: * Valide si une cartouche filtrante "S" est installée en amont.

MF	SMF	AK
		
0,1 µm	0,01 µm	charbon actif
2	1	1*
1	1	1
		charbon actif
1,5 à 65	1,5 à 65	1,5 à 45
70	80	60

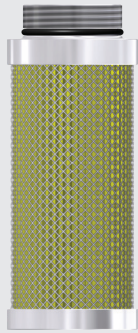

MF		SMF		AK	
DONALDSON	EVOAIR	DONALDSON	EVOAIR	DONALDSON	EVOAIR
MF 02/05	EDO 0205 MF AL	SMF 02/05	EDO 0205 SMF AL	AK 02/05	EDO 0205 AK/A AL
/	EDO 0210 MF AL	/	EDO 0210 SMF AL	/	EDO 0210 AK/A AL
MF 03/05	EDO 0305 MF AL	SMF 03/05	EDO 0305 SMF AL	AK 03/05	EDO 0305 AK/A AL
MF 03/10	EDO 0310 MF AL	SMF 03/10	EDO 0310 SMF AL	AK 03/10	EDO 0310 AK/A AL
MF 04/10	EDO 0410 MF AL	SMF 04/10	EDO 0410 SMF AL	AK 04/10	EDO 0410 AK/A AL
MF 04/20	EDO 0420 MF AL	SMF 04/20	EDO 0420 SMF AL	AK 04/20	EDO 0420 AK/A AL
MF 05/20	EDO 0520 MF AL	SMF 05/20	EDO 0520 SMF AL	AK 05/20	EDO 0520 AK/A AL
MF 05/25	EDO 0525 MF AL	SMF 05/25	EDO 0525 SMF AL	AK 05/25	EDO 0525 AK/A AL
MF 07/25	EDO 0725 MF AL	SMF 07/25	EDO 0725 SMF AL	AK 07/25	EDO 0725 AK/A AL
MF 07/30	EDO 0730 MF AL	SMF 07/30	EDO 0730 SMF AL	AK 07/30	EDO 0730 AK/A AL
MF 10/30	EDO 1030 MF AL	SMF 10/30	EDO 1030 SMF AL	AK 10/30	EDO 1030 AK/A AL
MF 15/30	EDO 1530 MF AL	SMF 15/30	EDO 1530 SMF AL	AK 15/30	EDO 1530 AK/A AL
MF 20/30	EDO 2030 MF AL	SMF 20/30	EDO 2030 SMF AL	AK 20/30	EDO 2030 AK/A AL
MF 30/30	EDO 3030 MF AL	SMF 30/30	EDO 3030 SMF AL	AK 30/30	EDO 3030 AK/A AL
MF 30/50	EDO 3050 MF AL	SMF 30/50	EDO 3050 SMF AL	AK 30/50	EDO 3050 AK/A AL

DONALDSON '80 series

DONALDSON '80 SERIES Embouts Aluminium	PE	FF	MF
			
Retention particules	3 µm	0,1 µm	0,1 µm
Classe de qualité - solides ⁽¹⁾	6	2	2
Classe de qualité - Huile ⁽¹⁾	-	2	1
Media Filtrant	fibres acrylique, cellulose		micro fibres de borosilicate
Température de fct.[°C]	1,5 à 65	1,5 à 65	1,5 à 65
DP (élément neuf) [mbar]	10	50	70

	PE		FF		MF	
	DONALDSON	EVOAIR	DONALDSON	EVOAIR	DONALDSON	EVOAIR
	PE 03/1	EDO 031 PE/P AL	FF 03/1	EDO 031 FF AL	MF 03/1	EDO 031 MF AL
	PE 03/1,5	EDO 031.5 PE/P AL	FF 03/1,5	EDO 031.5 FF AL	MF 03/1,5	EDO 031.5 MF AL
	PE 04/1,5	EDO 041.5 PE/P AL	FF 04/1,5	EDO 041.5 FF AL	MF 04/1,5	EDO 041.5 MF AL
	PE 04/2,5	EDO 042.5 PE/P AL	FF 04/2,5	EDO 042.5 FF AL	MF 04/2,5	EDO 042.5 MF AL
	PE 05/2,5	EDO 052.5 PE/P AL	FF 05/2,5	EDO 052.5 FF AL	MF 05/2,5	EDO 052.5 MF AL
	PE 05/3	EDO 053 PE/P AL	FF 05/3	EDO 053 FF AL	MF 05/3	EDO 053 MF AL
	PE 10/3	EDO 103 PE/P AL	FF 10/3	EDO 103 FF AL	MF 10/3	EDO 103 MF AL
	PE 15/3	EDO 153 PE/P AL	FF 15/3	EDO 153 FF AL	MF 15/3	EDO 153 MF AL
	PE 20/3	EDO 203 PE/P AL	FF 20/3	EDO 203 FF AL	MF 20/3	EDO 203 MF AL
	PE 30/3	EDO 303 PE/P AL	FF 30/3	EDO 303 FF AL	MF 30/3	EDO 303 MF AL
	PE 30/5	EDO 305 PE/P AL	FF 30/5	EDO 305 FF AL	MF 30/5	EDO 305 MF AL



NOTE: * Valide si une cartouche filtrante "S" est installée en amont.

SMF	AK
	
0,01 µm	charbon actif
1	1*
1	1
	charbon actif
1,5 à 65	1,5 à 45
80	60

SMF		AK	
DONALDSON	EVOAIR	DONALDSON	EVOAIR
SMF 03/1	EDO 031 SMF AL	AK 03/1	EDO 031 AK/A AL
SMF 03/1,5	EDO 031.5 SMF AL	AK 03/1,5	EDO 031.5 AK/A AL
SMF 04/1,5	EDO 041.5 SMF AL	AK 04/1,5	EDO 041.5 AK/A AL
SMF 04/2,5	EDO 042.5 SMF AL	AK 04/2,5	EDO 042.5 AK/A AL
SMF 05/2,5	EDO 052.5 SMF AL	AK 05/2,5	EDO 052.5 AK/A AL
SMF 05/3	EDO 053 SMF AL	AK 05/3	EDO 053 AK/A AL
SMF 10/3	EDO 103 SMF AL	AK 10/3	EDO 103 AK/A AL
SMF 15/3	EDO 153 SMF AL	AK 15/3	EDO 153 AK/A AL
SMF 20/3	EDO 203 SMF AL	AK 20/3	EDO 203 AK/A AL
SMF 30/3	EDO 303 SMF AL	AK 30/3	EDO 303 AK/A AL
SMF 30/5	EDO 305 SMF AL	AK 30/5	EDO 305 AK/A AL



ELEMENTS FILTRANTS ALTERNATIFS EXEMPTS DE SILICONE ET DE GRAISSE

DONALDSON

	PEP	FFP	MFP
DONALDSON			
Embout plastique Exempt d'huile et graisses			
Retention particules	3 µm	0,1 µm	0,1 µm
Classe de qualité - solides ⁽¹⁾	6	2	2
Classe de qualité - Huile ⁽¹⁾	-	2	2
Media Filtrant	fibres acrylique, cellulose	micro fibres de borosilicate	
Température de fct. [°C]	1,5 à 65	1,5 à 65	1,5 à 65
DP (élément neuf) [mbar]	10	50	50

	PEP		FFP		MFP	
	DONALDSON	EVOAIR	DONALDSON	EVOAIR	DONALDSON	EVOAIR
	PEP 02/05	EDO 0205 PEP/P	FFP 02/05	EDO 0205 FFP	MFP 02/05	EDO 0205 MFP
	PEP 03/05	EDO 0305 PEP/P	FFP 03/05	EDO 0305 FFP	MFP 03/05	EDO 0305 MFP
	PEP 03/10	EDO 0310 PEP/P	FFP 03/10	EDO 0310 FFP	MFP 03/10	EDO 0310 MFP
	PEP 04/10	EDO 0410 PEP/P	FFP 04/10	EDO 0410 FFP	MFP 04/10	EDO 0410 MFP
	PEP 04/20	EDO 0420 PEP/P	FFP 04/20	EDO 0420 FFP	MFP 04/20	EDO 0420 MFP
	PEP 05/20	EDO 0520 PEP/P	FFP 05/20	EDO 0520 FFP	MFP 05/20	EDO 0520 MFP
	PEP 05/25	EDO 0525 PEP/P	FFP 05/25	EDO 0525 FFP	MFP 05/25	EDO 0525 MFP
	PEP 07/25	EDO 0725 PEP/P	FFP 07/25	EDO 0725 FFP	MFP 07/25	EDO 0725 MFP
	PEP 07/30	EDO 0730 PEP/P	FFP 07/30	EDO 0730 FFP	MFP 07/30	EDO 0730 MFP
	PEP 10/30	EDO 1030 PEP/P	FFP 10/30	EDO 1030 FFP	MFP 10/30	EDO 1030 MFP
	PEP 15/30	EDO 1530 PEP/P	FFP 15/30	EDO 1530 FFP	MFP 15/30	EDO 1530 MFP
	PEP 20/30	EDO 2030 PEP/P	FFP 20/30	EDO 2030 FFP	MFP 20/30	EDO 2030 MFP
	PEP 30/30	EDO 3030 PEP/P	FFP 30/30	EDO 3030 FFP	MFP 30/30	EDO 3030 MFP
	PEP 30/50	EDO 3050 PEP/P	FFP 30/50	EDO 3050 FFP	MFP 30/50	EDO 3050 MFP



NOTE: * Valide si une cartouche filtrante "S" est installée en amont.

SMFP	AKP
	
0,01 µm	charbon actif
1	1*
1	1
micro fibres de borosilicate	charbon actif
1,5 à 65	1,5 à 45
80	60

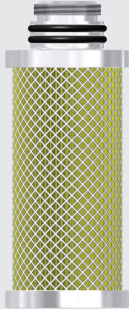
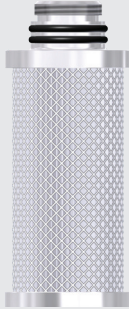

SMFP		AKP	
DONALDSON	EVOAIR	DONALDSON	EVOAIR
SMFP 02/05	EDO 0205 SMFP	AKP 02/05	EDO 0205 AKP
SMFP 03/05	EDO 0305 SMFP	AKP 03/05	EDO 0305 AKP
SMFP 03/10	EDO 0310 SMFP	AKP 03/10	EDO 0310 AKP
SMFP 04/10	EDO 0410 SMFP	AKP 04/10	EDO 0410 AKP
SMFP 04/20	EDO 0420 SMFP	AKP 04/20	EDO 0420 AKP
SMFP 05/20	EDO 0520 SMFP	AKP 05/20	EDO 0520 AKP
SMFP 05/25	EDO 0525 SMFP	AKP 05/25	EDO 0525 AKP
SMFP 07/25	EDO 0725 SMFP	AKP 07/25	EDO 0725 AKP
SMFP 07/30	EDO 0730 SMFP	AKP 07/30	EDO 0730 AKP
SMFP 10/30	EDO 1030 SMFP	AKP 10/30	EDO 1030 AKP
SMFP 15/30	EDO 1530 SMFP	AKP 15/30	EDO 1530 AKP
SMFP 20/30	EDO 2030 SMFP	AKP 20/30	EDO 2030 AKP
SMFP 30/30	EDO 3030 SMFP	AKP 30/30	EDO 3030 AKP
SMFP 30/50	EDO 3050 SMFP	AKP 30/50	EDO 3050 AKP

ELEMENTS FILTRANTS ALTERNATIFS EXEMPTS DE SILICONE ET DE GRAISSE

DONALDSON

	PEP	FFP	MFP
DONALDSON			
Embout Aluminium Exempt d'huile et graisses			
Retention particules	3 µm	0,1 µm	0,1 µm
Classe de qualité - solides ⁽¹⁾	6	2	2
Classe de qualité - Huile ⁽¹⁾	-	2	2
Media Filtrant	fibres acrylique, cellulose	micro fibres de borosilicate	
Température de fct.[°C]	1,5 à 65	1,5 à 65	1,5 à 65
DP (élément neuf) [mbar]	10	50	50

	PEP		FFP		MFP	
	DONALDSON	EVOAIR	DONALDSON	EVOAIR	DONALDSON	EVOAIR
	PEP 02/05	EDO 0205 PEP/P AL	FFP 02/05	EDO 0205 FFP AL	MFP 02/05	EDO 0205 MFP AL
	PEP 03/05	EDO 0305 PEP/P AL	FFP 03/05	EDO 0305 FFP AL	MFP 03/05	EDO 0305 MFP AL
	PEP 03/10	EDO 0310 PEP/P AL	FFP 03/10	EDO 0310 FFP AL	MFP 03/10	EDO 0310 MFP AL
	PEP 04/10	EDO 0410 PEP/P AL	FFP 04/10	EDO 0410 FFP AL	MFP 04/10	EDO 0410 MFP AL
	PEP 04/20	EDO 0420 PEP/P AL	FFP 04/20	EDO 0420 FFP AL	MFP 04/20	EDO 0420 MFP AL
	PEP 05/20	EDO 0520 PEP/P AL	FFP 05/20	EDO 0520 FFP AL	MFP 05/20	EDO 0520 MFP AL
	PEP 05/25	EDO 0525 PEP/P AL	FFP 05/25	EDO 0525 FFP AL	MFP 05/25	EDO 0525 MFP AL
	PEP 07/25	EDO 0725 PEP/P AL	FFP 07/25	EDO 0725 FFP AL	MFP 07/25	EDO 0725 MFP AL
	PEP 07/30	EDO 0730 PEP/P AL	FFP 07/30	EDO 0730 FFP AL	MFP 07/30	EDO 0730 MFP AL
	PEP 10/30	EDO 1030 PEP/P AL	FFP 10/30	EDO 1030 FFP AL	MFP 10/30	EDO 1030 MFP AL
	PEP 15/30	EDO 1530 PEP/P AL	FFP 15/30	EDO 1530 FFP AL	MFP 15/30	EDO 1530 MFP AL
	PEP 20/30	EDO 2030 PEP/P AL	FFP 20/30	EDO 2030 FFP AL	MFP 20/30	EDO 2030 MFP AL
	PEP 30/30	EDO 3030 PEP/P AL	FFP 30/30	EDO 3030 FFP AL	MFP 30/30	EDO 3030 MFP AL
	PEP 30/50	EDO 3050 PEP/P AL	FFP 30/50	EDO 3050 FFP AL	MFP 30/50	EDO 3050 MFP AL



SMFP	AKP
	
0,01 µm	charbon actif
1	1*
1	1
micro fibres de borosilicate	charbon actif
1,5 à 65	1,5 à 45
80	60

SMFP		AKP	
DONALDSON	EVOAIR	DONALDSON	EVOAIR
SMFP 02/05	EDO 0205 SMFP AL	AKP 02/05	EDO 0205 AKP AL
SMFP 03/05	EDO 0305 SMFP AL	AKP 03/05	EDO 0305 AKP AL
SMFP 03/10	EDO 0310 SMFP AL	AKP 03/10	EDO 0310 AKP AL
SMFP 04/10	EDO 0410 SMFP AL	AKP 04/10	EDO 0410 AKP AL
SMFP 04/20	EDO 0420 SMFP AL	AKP 04/20	EDO 0420 AKP AL
SMFP 05/20	EDO 0520 SMFP AL	AKP 05/20	EDO 0520 AKP AL
SMFP 05/25	EDO 0525 SMFP AL	AKP 05/25	EDO 0525 AKP AL
SMFP 07/25	EDO 0725 SMFP AL	AKP 07/25	EDO 0725 AKP AL
SMFP 07/30	EDO 0730 SMFP AL	AKP 07/30	EDO 0730 AKP AL
SMFP 10/30	EDO 1030 SMFP AL	AKP 10/30	EDO 1030 AKP AL
SMFP 15/30	EDO 1530 SMFP AL	AKP 15/30	EDO 1530 AKP AL
SMFP 20/30	EDO 2030 SMFP AL	AKP 20/30	EDO 2030 AKP AL
SMFP 30/30	EDO 3030 SMFP AL	AKP 30/30	EDO 3030 AKP AL
SMFP 30/50	EDO 3050 SMFP AL	AKP 30/50	EDO 3050 AKP AL



NOTE: * Valide si une cartouche filtrante "S" est installée en amont.

ELEMENTS FILTRANTS ALTERNATIFS STERILE/VENT

DONALDSON

	P-SRF	P-BE
DONALDSON STERILE EMBOUS INOX 1.4301 (304)		
Retention particules	0,01 µm	0,01 µm
Classe de qualité - solides ⁽¹⁾	1	1
Classe de qualité - Huile ⁽¹⁾	-	-
Media Filtrant	micro fibres de borosilicate	
Température de fct.[°C]	-20 à 150	-20 à 150
DP (élément neuf) [mbar]	80 mbar	80 mbar

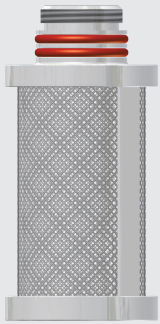

	P-SRF				P-BE	
	DONALDSON	ZANDER	DOMNICK HUNTER	EVOAIR	DONALDSON	EVOAIR
	P-SRF 02/10	EST-R 02/10	ME 02/10	EDO 0210 P-SRF	P-BE 03/10	EDO 0310 P-BE
	P-SRF 03/10	EST-R 03/10	ME 03/10	EDO 0310 P-SRF	P-BE 05/25	EDO 0525 P-BE
	P-SRF 04/10	EST-R 04/10	ME 04/10	EDO 0410 P-SRF	P-BE 05/30	EDO 0530 P-BE
	P-SRF 04/20	EST-R 04/20	ME 04/20	EDO 0420 P-SRF	P-BE 10/30	EDO 1030 P-BE
	P-SRF 05/20	EST-R 05/20	ME 05/20	EDO 0520 P-SRF	P-BE 20/30	EDO 2030 P-BE
	P-SRF 05/25	EST-R 05/25	ME 05/25	EDO 0525 P-SRF	P-BE 30/30	EDO 3030 P-BE
	P-SRF 07/25	EST-R 07/25	ME 07/25	EDO 0725 P-SRF		
	P-SRF 05/30	EST-R 05/30	ME 05/30	EDO 0530 P-SRF		
	P-SRF 07/30	EST-R 07/30	ME 07/30	EDO 0730 P-SRF		
	P-SRF 10/30	EST-R 10/30	ME 10/30	EDO 1030 P-SRF		
	P-SRF 15/30	EST-R 15/30	ME 15/30	EDO 1530 P-SRF		
	P-SRF 20/30	EST-R 20/30	ME 20/30	EDO 2030 P-SRF		
	P-SRF 30/30	EST-R 30/30	ME 30/30	EDO 3030 P-SRF		
	P-SRF 30/50	EST-R 30/50	ME 30/50	EDO 3050 P-SRF		

DONALDSON STERILE EMBOUTS INOX 1.4301 (304)	SRF (90' series)	SRF (80' series)
		
Retention particules	0,01 µm	0,01 µm
Classe de qualité - solides ⁽¹⁾	1	1
Classe de qualité - Huile ⁽¹⁾	-	-
Media Filtrant	micro fibres de borosilicate	
Température de fct.[°C]	-20 à 150	-20 à 150
DP (élément neuf) [mbar]	80 mbar	80 mbar



	SRF (90' series)				SRF (80' series)			
	DONALDSON	ZANDER	DOMNICK HUNTER	EVOAIR	DONALDSON	ZANDER	DOMNICK HUNTER	EVOAIR
	SRF 02/10	ET-R 02/10	MER 02/10	EDO 0210 SRF	SRF 3/1	ET-R 3/1	ME 3/1	EDO 031 SRF
	SRF 03/10	ET-R 03/10	MER 03/10	EDO 0310 SRF	SRF 3/1,5	ET-R 3/1,5	ME 3/1,5	EDO 031,5 SRF
	SRF 04/10	ET-R 04/10	MER 04/10	EDO 0410 SRF	SRF 4/1,5	ET-R 4/1,5	ME 4/1,5	EDO 041,5 SRF
	SRF 04/20	ET-R 04/20	MER 04/20	EDO 0420 SRF	SRF 4/2,5	ET-R 4/2,5	ME 4/2,5	EDO 042,5 SRF
	SRF 05/20	ET-R 05/20	MER 05/20	EDO 0520 SRF	SRF 5/2,5	ET-R 5/2,5	ME 5/2,5	EDO 052,5 SRF
	SRF 05/25	ET-R 05/25	MER 05/25	EDO 0525 SRF	SRF 5/3	ET-R 5/3	ME 5/3	EDO 053 SRF
	SRF 07/25	ET-R 07/25	MER 07/25	EDO 0725 SRF	SRF 10/3	ET-R 10/3	ME 10/3	EDO 103 SRF
	SRF 05/30	ET-R 05/30	MER 05/30	EDO 0530 SRF	SRF 15/3	ET-R 15/3	ME 15/3	EDO 153 SRF
	SRF 07/30	ET-R 07/30	MER 07/30	EDO 0730 SRF	SRF 20/3	ET-R 20/3	ME 20/3	EDO 203 SRF
	SRF 10/30	ET-R 10/30	MER 10/30	EDO 1030 SRF	SRF 30/3	ET-R 30/3	ME 30/3	EDO 303 SRF
	SRF 15/30	ET-R 15/30	MER 15/30	EDO 1530 SRF	SRF 30/5	ET-R 30/5	ME 30/5	EDO 305 SRF
	SRF 20/30	ET-R 20/30	MER 20/30	EDO 2030 SRF				
	SRF 30/30	ET-R 30/30	MER 30/30	EDO 3030 SRF				
	SRF 30/50	ET-R 30/50	MER 30/50	EDO 3050 SRF				

ELEMENTS FILTRANTS ALTERNATIFS DE PROCESS

DONALDSON

DONALDSON PROCESS EMBOUTS INOX 1.4301 (304)	P-SM (25 µm)	P-SM (5 µm)	P-GS (20 µm)
			
Retention particules	25 µm	5 µm	20 µm
Classe de qualité - solides ⁽¹⁾	-	-	-
Classe de qualité - Huile ⁽¹⁾	-	-	-
Media Filtrant	stainless steel mesh		sintered inox
Température de fct.[°C]	0 à 150	0 à 150	0 à 150
DP (élément neuf) [mbar]	60	60	60

	P-SM (25 µm)		P-SM (5 µm)		P-GS (20 µm)	
	DONALDSON	EVOAIR	DONALDSON	EVOAIR	DONALDSON	EVOAIR
P-SM 02/05 25 µm	EDO 0205 P-SM (25µm)		P-SM 02/05 5 µm	EDO 0205 P-SM (5µm)	P-GS 02/05 25µm	/
P-SM 03/05 25 µm	EDO 0305 P-SM (25µm)		P-SM 03/05 5 µm	EDO 0305 P-SM (5µm)	P-GS 03/05 25µm	/
P-SM 03/10 25 µm	EDO 0310 P-SM (25µm)		P-SM 03/10 5 µm	EDO 0310 P-SM (5µm)	P-GS 03/10 25µm	EDO 0310 P-GS (20µm)
P-SM 04/10 25 µm	EDO 0410 P-SM (25µm)		P-SM 04/10 5 µm	EDO 0410 P-SM (5µm)	P-GS 04/10 25µm	EDO 0410 P-GS (20µm)
P-SM 04/20 25 µm	EDO 0420 P-SM (25µm)		P-SM 04/20 5 µm	EDO 0420 P-SM (5µm)	P-GS 04/20 25µm	EDO 0420 P-GS (20µm)
P-SM 05/20 25 µm	EDO 0520 P-SM (25µm)		P-SM 05/20 5 µm	EDO 0520 P-SM (5µm)	P-GS 05/20 25µm	EDO 0520 P-GS (20µm)
P-SM 05/25 25 µm	EDO 0525 P-SM (25µm)		P-SM 05/25 5 µm	EDO 0525 P-SM (5µm)	P-GS 05/25 25µm	EDO 0525 P-GS (20µm)
P-SM 07/25 25 µm	EDO 0725 P-SM (25µm)		P-SM 07/25 5 µm	EDO 0725 P-SM (5µm)	P-GS 07/25 25µm	EDO 0725 P-GS (20µm)
P-SM 07/30 25 µm	EDO 0730 P-SM (25µm)		P-SM 07/30 5 µm	EDO 0730 P-SM (5µm)	P-GS 07/30 25µm	EDO 0730 P-GS (20µm)
P-SM 10/30 25 µm	EDO 1030 P-SM (25µm)		P-SM 10/30 5 µm	EDO 1030 P-SM (5µm)	P-GS 10/30 25µm	EDO 1030 P-GS (20µm)
P-SM 15/30 25 µm	EDO 1530 P-SM (25µm)		P-SM 15/30 5 µm	EDO 1530 P-SM (5µm)	P-GS 15/30 25µm	EDO 1530 P-GS (20µm)
P-SM 20/30 25 µm	EDO 2030 P-SM (25µm)		P-SM 20/30 5 µm	EDO 2030 P-SM (5µm)	P-GS 20/30 25µm	EDO 2030 P-GS (20µm)
P-SM 30/30 25 µm	EDO 3030 P-SM (25µm)		P-SM 30/30 5 µm	EDO 3030 P-SM (5µm)	P-GS 30/30 25µm	EDO 3030 P-GS (20µm)
P-SM 30/50 25 µm	EDO 3050 P-SM (25µm)		P-SM 30/50 5 µm	EDO 3050 P-SM (5µm)	P-GS 30/50 25µm	EDO 3050 P-GS (20µm)

DONALDSON PROCESS EMBOUS INOX 1.4301 (304)	P-GS (1 µm)	P-GS/VE (20 µm)	P-GS/VE (1 µm)
			
Retention particules	1 µm	20 µm	1 µm
Classe de qualité - solides ⁽¹⁾	-	-	-
Classe de qualité - Huile ⁽¹⁾	-	-	-
Media Filtrant	sintered inox		
Température de fct.[°C]	0 à 150	0 à 150	0 à 150
DP (élément neuf) [mbar]	60	60	60

	P-GS (1 µm)		P-GS/VE (20 µm)		P-GS/VE (1 µm)	
	DONALDSON	EVOAIR	DONALDSON	EVOAIR	DONALDSON	EVOAIR
P-GS 02/05 5 µm	/	/	P-GS(VE) 02/05 25 µm	/	P-GS(VE) 02/05 5 µm	/
P-GS 03/05 5 µm	/	/	P-GS(VE) 03/05 25 µm	/	P-GS(VE) 03/05 5 µm	/
P-GS 03/10 5 µm	EDO 0310 P-GS (1µm)		P-GS(VE) 03/10 25 µm	EDO 0310 P-GS(VE) (20µm)	P-GS(VE) 03/10 5 µm	EDO 0310 P-GS(VE) (1µm)
P-GS 04/10 5 µm	EDO 0410 P-GS (1µm)		P-GS(VE) 04/10 25 µm	EDO 0410 P-GS(VE) (20µm)	P-GS(VE) 04/10 5 µm	EDO 0410 P-GS(VE) (1µm)
P-GS 04/20 5 µm	EDO 0420 P-GS (1µm)		P-GS(VE) 04/20 25 µm	EDO 0420 P-GS(VE) (20µm)	P-GS(VE) 04/20 5 µm	EDO 0420 P-GS(VE) (1µm)
P-GS 05/20 5 µm	EDO 0520 P-GS (1µm)		P-GS(VE) 05/20 25 µm	EDO 0520 P-GS(VE) (20µm)	P-GS(VE) 05/20 5 µm	EDO 0520 P-GS(VE) (1µm)
P-GS 05/25 5 µm	EDO 0525 P-GS (1µm)		P-GS(VE) 05/25 25 µm	EDO 0525 P-GS(VE) (20µm)	P-GS(VE) 05/25 5 µm	EDO 0525 P-GS(VE) (1µm)
P-GS 07/25 5 µm	EDO 0725 P-GS (1µm)		P-GS(VE) 07/25 25 µm	EDO 0725 P-GS(VE) (20µm)	P-GS(VE) 07/25 5 µm	EDO 0725 P-GS(VE) (1µm)
P-GS 07/30 5 µm	EDO 0730 P-GS (1µm)		P-GS(VE) 07/30 25 µm	EDO 0730 P-GS(VE) (20µm)	P-GS(VE) 07/30 5 µm	EDO 0730 P-GS(VE) (1µm)
P-GS 10/30 5 µm	EDO 1030 P-GS (1µm)		P-GS(VE) 10/30 25 µm	EDO 1030 P-GS(VE) (20µm)	P-GS(VE) 10/30 5 µm	EDO 1030 P-GS(VE) (1µm)
P-GS 15/30 5 µm	EDO 1530 P-GS (1µm)		P-GS(VE) 15/30 25 µm	EDO 1530 P-GS(VE) (20µm)	P-GS(VE) 15/30 5 µm	EDO 1530 P-GS(VE) (1µm)
P-GS 20/30 5 µm	EDO 2030 P-GS (1µm)		P-GS(VE) 20/30 25 µm	EDO 2030 P-GS(VE) (20µm)	P-GS(VE) 20/30 5 µm	EDO 2030 P-GS(VE) (1µm)
P-GS 30/30 5 µm	EDO 3030 P-GS (1µm)		P-GS(VE) 30/30 25 µm	EDO 3030 P-GS(VE) (20µm)	P-GS(VE) 30/30 5 µm	EDO 3030 P-GS(VE) (1µm)
P-GS 30/50 5 µm	EDO 3050 P-GS (1µm)		P-GS(VE) 30/50 25 µm	EDO 3050 P-GS(VE) (20µm)	P-GS(VE) 30/50 5 µm	EDO 3050 P-GS(VE) (1µm)

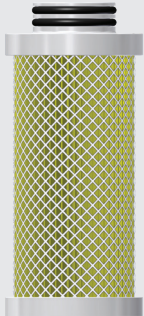
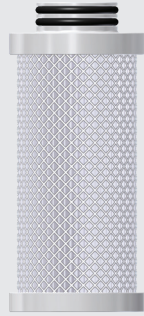

ELEMENTS FILTRANTS ALTERNATIFS DE PROCESS

DONALDSON

	P-SB	P-PE	P-FF
DONALDSON PROCESS EMBOUTS INOX 1.4301 (304)			
	Retention particules	25 µm	3 µm
Classe de qualité - solides ⁽¹⁾	-	6	2
Classe de qualité - Huile ⁽¹⁾	-	-	2
Media Filtrant	Laiton fritté	fibres acrylique, cellulose	micro fibres de borosilicate
Température de fct. [°C]	1,5 à 65	1,5 à 65	1,5 à 120
DP (élément neuf) [mbar]	20	10	50

	P-SB		P-PE		P-FF	
	DONALDSON	EVOAIR	DONALDSON	EVOAIR	DONALDSON	EVOAIR
	P-SB 02/05	EDO 0205 P-SB	P-PE 02/05	EDO 0205 P-PE/P	P-FF 02/05	EDO 0205 P-FF
	P-SB 03/05	EDO 0305 P-SB	P-PE 03/05	EDO 0305 P-PE/P	P-FF 03/05	EDO 0305 P-FF
	P-SB 03/10	EDO 0310 P-SB	P-PE 03/10	EDO 0310 P-PE/P	P-FF 03/10	EDO 0310 P-FF
	P-SB 04/10	EDO 0410 P-SB	P-PE 04/10	EDO 0410 P-PE/P	P-FF 04/10	EDO 0410 P-FF
	P-SB 04/20	EDO 0420 P-SB	P-PE 04/20	EDO 0420 P-PE/P	P-FF 04/20	EDO 0420 P-FF
	P-SB 05/20	EDO 0520 P-SB	P-PE 05/20	EDO 0520 P-PE/P	P-FF 05/20	EDO 0520 P-FF
	P-SB 05/25	EDO 0525 P-SB	P-PE 05/25	EDO 0525 P-PE/P	P-FF 05/25	EDO 0525 P-FF
	P-SB 07/25	EDO 0725 P-SB	P-PE 07/25	EDO 0725 P-PE/P	P-FF 07/25	EDO 0725 P-FF
	P-SB 07/30	EDO 0730 P-SB	P-PE 07/30	EDO 0730 P-PE/P	P-FF 07/30	EDO 0730 P-FF
	P-SB 10/30	EDO 1030 P-SB	P-PE 10/30	EDO 1030 P-PE/P	P-FF 10/30	EDO 1030 P-FF
	P-SB 15/30	EDO 1530 P-SB	P-PE 15/30	EDO 1530 P-PE/P	P-FF 15/30	EDO 1530 P-FF
	P-SB 20/30	EDO 2030 P-SB	P-PE 20/30	EDO 2030 P-PE/P	P-FF 20/30	EDO 2030 P-FF
	P-SB 30/30	EDO 3030 P-SB	P-PE 30/30	EDO 3030 P-PE/P	P-FF 30/30	EDO 3030 P-FF
	P-SB 30/50	EDO 3050 P-SB	P-PE 30/50	EDO 3050 P-PE/P	P-FF 30/50	EDO 3050 P-FF





NOTE: * Valide si une cartouche filtrante "S" est installée en amont.

	P-MF	P-SMF	P-AK
DONALDSON PROCESS EMBOUTS INOX 1.4301 (304)			
	0,1 µm	0,01 µm	charbon actif
Retention particules	0,1 µm	0,01 µm	charbon actif
Classe de qualité - solides ⁽¹⁾	2	1	1*
Classe de qualité - Huile ⁽¹⁾	2	1	1
Media Filtrant	micro fibres de borosilicate		charbon actif
Température de fct.[°C]	1,5 à 120	1,5 à 65	1,5 à 45
DP (élément neuf) [mbar]	50	80	60

	P-MF		P-SMF		P-AK	
	DONALDSON	EVOAIR	DONALDSON	EVOAIR	DONALDSON	EVOAIR
	P-MF 02/05	EDO 0205 P-MF	P-SMF 02/05	EDO 0205 P-SMF	P-AK 02/05	EDO 0205 P-AK
	P-MF 03/05	EDO 0305 P-MF	P-SMF 03/05	EDO 0305 P-SMF	P-AK 03/05	EDO 0305 P-AK
	P-MF 03/10	EDO 0310 P-MF	P-SMF 03/10	EDO 0310 P-SMF	P-AK 03/10	EDO 0310 P-AK
	P-MF 04/10	EDO 0410 P-MF	P-SMF 04/10	EDO 0410 P-SMF	P-AK 04/10	EDO 0410 P-AK
	P-MF 04/20	EDO 0420 P-MF	P-SMF 04/20	EDO 0420 P-SMF	P-AK 04/20	EDO 0420 P-AK
	P-MF 05/20	EDO 0520 P-MF	P-SMF 05/20	EDO 0520 P-SMF	P-AK 05/20	EDO 0520 P-AK
	P-MF 05/25	EDO 0525 P-MF	P-SMF 05/25	EDO 0525 P-SMF	P-AK 05/25	EDO 0525 P-AK
	P-MF 07/25	EDO 0725 P-MF	P-SMF 07/25	EDO 0725 P-SMF	P-AK 07/25	EDO 0725 P-AK
	P-MF 07/30	EDO 0730 P-MF	P-SMF 07/30	EDO 0730 P-SMF	P-AK 07/30	EDO 0730 P-AK
	P-MF 10/30	EDO 1030 P-MF	P-SMF 10/30	EDO 1030 P-SMF	P-AK 10/30	EDO 1030 P-AK
	P-MF 15/30	EDO 1530 P-MF	P-SMF 15/30	EDO 1530 P-SMF	P-AK 15/30	EDO 1530 P-AK
	P-MF 20/30	EDO 2030 P-MF	P-SMF 20/30	EDO 2030 P-SMF	P-AK 20/30	EDO 2030 P-AK
	P-MF 30/30	EDO 3030 P-MF	P-SMF 30/30	EDO 3030 P-SMF	P-AK 30/30	EDO 3030 P-AK
	P-MF 30/50	EDO 3050 P-MF	P-SMF 30/50	EDO 3050 P-SMF	P-AK 30/50	EDO 3050 P-AK

ELEMENTS FILTRANTS
 ALTERNATIFS





EKOMAK

EKOMAK Embouts Plastique	P	U	H	S	C
					
Retention particules	3 µm	1 µm	0,1 µm	0,01 µm	charbon actif
Classe de qualité - solides ⁽¹⁾	6	3	2	1	1*
Classe de qualité - Huile ⁽¹⁾	-	-	2	1	1
Media Filtrant	fibres acrylique, cellulose		micro fibres de borosilicate		charbon actif
Température de fct.[°C]	1,5 à 65	1,5 à 65	1,5 à 65	1,5 à 65	1,5 à 45
DP (élément neuf) [mbar]	10	20	50	80	60

EKOMAK	P		U		H		S		C	
	EVOAIR	EKOMAK	EVOAIR	EKOMAK	EVOAIR	EKOMAK	EVOAIR	EKOMAK	EVOAIR	
EP10	EEK 10 P/P	EU10	EEK 10 U/R	EH10	EEK 10 H/M	ES10	EEK 10 S/S	EC10	EEK 10 C/A	
EP15	EEK 15 P/P	EU15	EEK 15 U/R	EH15	EEK 15 H/M	ES15	EEK 15 S/S	EC15	EEK 15 C/A	
EP20	EEK 20 P/P	EU20	EEK 20 U/R	EH20	EEK 20 H/M	ES20	EEK 20 S/S	EC20	EEK 20 C/A	
EP30	EEK 30 P/P	EU30	EEK 30 U/R	EH30	EEK 30 H/M	ES30	EEK 30 S/S	EC30	EEK 30 C/A	
EP55	EEK 55 P/P	EU55	EEK 55 U/R	EH55	EEK 55 H/M	ES55	EEK 55 S/S	EC55	EEK 55 C/A	
EP95	EEK 95 P/P	EU95	EEK 95 U/R	EH95	EEK 95 H/M	ES95	EEK 95 S/S	EC95	EEK 95 C/A	
EP150	EEK 150 P/P	EU150	EEK 150 U/R	EH150	EEK 150 H/M	ES150	EEK 150 S/S	EC150	EEK 150 C/A	
EP220	EEK 220 P/P	EU220	EEK 220 U/R	EH220	EEK 220 H/M	ES220	EEK 220 S/S	EC220	EEK 220 C/A	
EP290	EEK 290 P/P	EU290	EEK 290 U/R	EH290	EEK 290 H/M	ES290	EEK 290 S/S	EC290	EEK 290 C/A	
EP430	EEK 430 P/P	EU430	EEK 430 U/R	EH430	EEK 430 H/M	ES430	EEK 430 S/S	EC430	EEK 430 C/A	
EP625	EEK 625 P/P	EU625	EEK 625 U/R	EH625	EEK 625 H/M	ES625	EEK 620 S/S	EC625	EEK 620 C/A	
EP775	EEK 775 P/P	EU775	EEK 775 U/R	EH775	EEK 775 H/M	ES775	EEK 775 S/S	EC775	EEK 775 C/A	

NOTE: * Valide si une cartouche filtrante "S" est installée en amont.

EKOMAK





	P	U	H	S	C
EKOMAK Embouts Aluminium					
	Retention particules	3 µm	1 µm	0,1 µm	0,01 µm
Classe de qualité - solides ⁽¹⁾	6	3	2	1	1*
Classe de qualité - Huile ⁽¹⁾	-	-	2	1	1
Media Filtrant	fibres acrylique, cellulose		micro fibres de borosilicate		charbon actif
Température de fct.[°C]	1,5 à 65	1,5 à 65	1,5 à 65	1,5 à 65	1,5 à 45
DP (élément neuf) [mbar]	10	20	50	80	60

	P		U		H		S		C	
	EKOMAK	EVOAIR	EKOMAK	EVOAIR	EKOMAK	EVOAIR	EKOMAK	EVOAIR	EKOMAK	EVOAIR
	EP10	EEK 10 P/P AL	EU10	EEK 10 U/R AL	EH10	EEK 10 H/M AL	ES10	EEK 10 S/S AL	EC10	EEK 10 C/A AL
	EP15	EEK 15 P/P AL	EU15	EEK 15 U/R AL	EH15	EEK 15 H/M AL	ES15	EEK 15 S/S AL	EC15	EEK 15 C/A AL
	EP20	EEK 20 P/P AL	EU20	EEK 20 U/R AL	EH20	EEK 20 H/M AL	ES20	EEK 20 S/S AL	EC20	EEK 20 C/A AL
	EP30	EEK 30 P/P AL	EU30	EEK 30 U/R AL	EH30	EEK 30 H/M AL	ES30	EEK 30 S/S AL	EC30	EEK 30 C/A AL
	EP55	EEK 55 P/P AL	EU55	EEK 55 U/R AL	EH55	EEK 55 H/M AL	ES55	EEK 55 S/S AL	EC55	EEK 55 C/A AL
	EP95	EEK 95 P/P AL	EU95	EEK 95 U/R AL	EH95	EEK 95 H/M AL	ES95	EEK 95 S/S AL	EC95	EEK 95 C/A AL
	EP150	EEK 150 P/P AL	EU150	EEK 150 U/R AL	EH150	EEK 150 H/M AL	ES150	EEK 150 S/S AL	EC150	EEK 150 C/A AL
	EP220	EEK 220 P/P AL	EU220	EEK 220 U/R AL	EH220	EEK 220 H/M AL	ES220	EEK 220 S/S AL	EC220	EEK 220 C/A AL
	EP290	EEK 290 P/P AL	EU290	EEK 290 U/R AL	EH290	EEK 290 H/M AL	ES290	EEK 290 S/S AL	EC290	EEK 290 C/A AL
	EP430	EEK 430 P/P AL	EU430	EEK 430 U/R AL	EH430	EEK 430 H/M AL	ES430	EEK 430 S/S AL	EC430	EEK 430 C/A AL
	EP625	EEK 625 P/P AL	EU625	EEK 625 U/R AL	EH625	EEK 625 H/M AL	ES625	EEK 620 S/S AL	EC625	EEK 620 C/A AL
	EP775	EEK 775 P/P AL	EU775	EEK 775 U/R AL	EH775	EEK 775 H/M AL	ES775	EEK 775 S/S AL	EC775	EEK 775 C/A AL

NOTE: * Valide si une cartouche filtrante "S" est installée en amont.

ELEMENTS FILTRANTS ALTERNATIFS





FIAC

	Q	P	D	C
FIAC Embouts Plastique				
Retention particules	3 µm	0,1 µm	0,01 µm	charbon actif
Classe de qualité - solides ⁽¹⁾	6	2	1	1*
Classe de qualité - Huile ⁽¹⁾	-	2	1	1
Media Filtrant	fibres acrylique, cellulose	micro fibres de borosilicate		charbon actif
Température de fct.[°C]	1,5 à 65	1,5 à 65	1,5 à 65	1,5 à 45
DP (élément neuf) [mbar]	10	50	80	60

	Q		P		D		C	
	FIAC	EVOAIR	FIAC	EVOAIR	FIAC	EVOAIR	FIAC	EVOAIR
	FQ 1000	EFC 1000 Q/P	FP 1000	EFC 1000 P/M	FD 1000	EFC 1000 D/S	FC 1000	EFC 1000 C/A
	FQ 1300	EFC 1300 Q/P	FP 1300	EFC 1300 P/M	FD 1300	EFC 1300 D/S	FC 1300	EFC 1300 C/A
	FQ 2000	EFC 2000 Q/P	FP 2000	EFC 2000 P/M	FD 2000	EFC 2000 D/S	FC 2000	EFC 2000 C/A
	FQ 3300	EFC 3300 Q/P	FP 3300	EFC 3300 P/M	FD 3300	EFC 3300 D/S	FC 3300	EFC 3300 C/A
	FQ 5600	EFC 5600 Q/P	FP 5600	EFC 5600 P/M	FD 5600	EFC 5600 D/S	FC 5600	EFC 5600 C/A
	FQ 8600	EFC 8500 Q/P	FP 8600	EFC 8500 P/M	FD 8600	EFC 8500 D/S	FC 8600	EFC 8500 C/A
	FQ 13000	EFC 13000 Q/P	FP 13000	EFC 13000 P/M	FD 13000	EFC 13000 D/S	FC 13000	EFC 13000 C/A
	FQ 16500	EFC 16500 Q/P	FP 16500	EFC 16500 P/M	FD 16500	EFC 16500 D/S	FC 16500	EFC 16500 C/A
	FQ 25000	EFC 25000 Q/P	FP 25000	EFC 25000 P/M	FD 25000	EFC 25000 D/S	FC 25000	EFC 25000 C/A

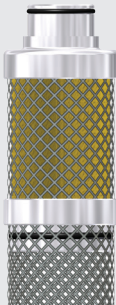
NOTE: * Valide si une cartouche filtrante "S" est installée en amont.



**ELEMENTS FILTRANTS
 ALTERNATIFS**
FINITE J

	3P	10C	7C	4C	A
FINITE Embouts Aluminium					
Retention particules	3 µm	1 µm	0,1 µm	0,01 µm	charbon actif
Classe de qualité - solides ⁽¹⁾	6	3	2	1	1*
Classe de qualité - Huile ⁽¹⁾	-	-	2	1	1
Media Filtrant	fibres acrylique, cellulose	micro fibres de borosilicate			charbon actif
Température de fct.[°C]	1,5 à 65	1,5 à 65	1,5 à 65	1,5 à 65	1,5 à 45
DP (élément neuf) [mbar]	10	20	50	80	60

	3P		10C		7C		4C		A	
	FINITE	EVOAIR	FINITE	EVOAIR	FINITE	EVOAIR	FINITE	EVOAIR	FINITE	EVOAIR
	3PJAK	EFI JAK 3P/P AL	10CJAK	EFI JAK 10C/R AL	7CPJAK	EFI JAK 7CP/M AL	4CJAK	EFI JAK 4C/S AL	AJAK	EFI JAK A/A AL
	3PJBK	EFI JBK 3P/P AL	10CJBK	EFI JBK 10C/R AL	7CPJBK	EFI JBK 7CP/M AL	4CJBK	EFI JBK 4C/S AL	AJBK	EFI JBK A/A AL
	3PJCK	EFI JCK 3P/P AL	10CJCK	EFI JCK 10C/R AL	7CPJCK	EFI JCK 7CP/M AL	4CJCK	EFI JCK 4C/S AL	AJCK	EFI JCK A/A AL
	3PJDK	EFI JDK 3P/P AL	10CJDK	EFI JDK 10C/R AL	7CPJDK	EFI JDK 7CP/M AL	4CJDK	EFI JDK 4C/S AL	AJDK	EFI JDK A/A AL
	3PJEK	EFI JEK 3P/P AL	10CJEK	EFI JEK 10C/R AL	7CPJEK	EFI JEK 7CP/M AL	4CJEK	EFI JEK 4C/S AL	AJEK	EFI JEK A/A AL

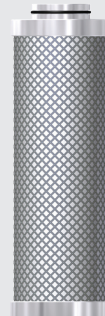

NOTE: * Valide si une cartouche filtrante "S" est installée en amont.

FINITE (ancien)

FINITE Embouts Aluminium	3P	10C	7C
			
Retention particules	3 µm	1 µm	0,1 µm
Classe de qualité - solides ⁽¹⁾	6	3	2
Classe de qualité - Huile ⁽¹⁾	-	-	2
Media Filtrant	fibres acrylique, cellulose		micro fibres de borosilicate
Température de fct.[°C]	1,5 à 65	1,5 à 65	1,5 à 65
DP (élément neuf) [mbar]	10	20	50

	3P		10C		7C	
	FINITE	EVOAIR	FINITE	EVOAIR	FINITE	EVOAIR
	3PWC11-035	EFI 11-035 3PWC/P AL	10CWC11-035	EFI 11-035 10CWC/R AL	7CPWC11-035	EFI 11-035 7CPWC/M AL
	3PWC15-070	EFI 15-070 3PWC/P AL	10CWC15-070	EFI 15-070 10CWC/R AL	7CPWC15-070	EFI 15-070 7CPWC/M AL
	3PWC23-130	EFI 23-130 3PWC/P AL	10CWC23-130	EFI 23-130 10CWC/R AL	7CPWC23-130	EFI 23-130 7CPWC/M AL



NOTE: * Valide si une cartouche filtrante "S" est installée en amont.

4C	A
	
0,01 µm	charbon actif
1	1*
1	1
	charbon actif
1,5 à 65	1,5 à 45
80	60

4C		A	
FINITE	EVOAIR	FINITE	EVOAIR
4CWC11-035	EFI 11-035 4CWC/S AL	AWC11-035	EFI 11-035 AWC/AAL
4CWC15-070	EFI 15-070 4CWC/S AL	AWC15-070	EFI 15-070 AWC/AAL
4CWC23-130	EFI 23-130 4CWC/S AL	AWC23-130	EFI 23-130 AWC/AAL

ELEMENTS FILTRANTS
 ALTERNATIFS





FUSHENG (nouveau)

	U	H	C
FUSHENG (nouveau) Embouts Plastique			
	1 µm	0,01 µm	charbon actif
Retention particules	1 µm	0,01 µm	charbon actif
Classe de qualité - solides ⁽¹⁾	3	1	1*
Classe de qualité - Huile ⁽¹⁾	-	1	1
Media Filtrant	micro fibres de borosilicate		charbon actif
Température de fct.[°C]	1,5 à 65	1,5 à 65	1,5 à 45
DP (élément neuf) [mbar]	20	80	60

	U		H		C	
	FUSHENG	EVOAIR	FUSHENG	EVOAIR	FUSHENG	EVOAIR
FF005 U	EFS 005 U/R	FF005 H	EFS 005 H/S	FF005 C	EFS 005 C/A	
FF010 U	EFS 010 U/R	FF010 H	EFS 010 H/S	FF010 C	EFS 010 C/A	
FF015 U	EFS 015 U/R	FF015 H	EFS 015 H/S	FF015 C	EFS 015 C/A	
FF030 U	EFS 030 U/R	FF030 H	EFS 030 H/S	FF030 C	EFS 030 C/A	
FF050 U	EFS 050 U/R	FF050 H	EFS 050 H/S	FF050 C	EFS 050 C/A	
FF075 U	EFS 075 U/R	FF075 H	EFS 075 H/S	FF075 C	EFS 075 C/A	
FF125 U	EFS 125 U/R	FF125 H	EFS 125 H/S	FF125 C	EFS 125 C/A	
FF175 U	EFS 175 U/R	FF175 H	EFS 175 H/S	FF175 C	EFS 175 C/A	
FF250 U	EFS 250 U/R	FF250 H	EFS 250 H/S	FF250 C	EFS 250 C/A	
FF300 U	EFS 250 U/R	FF300 H	EFS 250 H/S	FF300 C	EFS 250 C/A	
FF500 U	EFS 500 U/R	FF500 H	EFS 500 H/S	FF500 C	EFS 500 C/A	

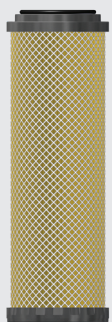
NOTE: * Valide si une cartouche filtrante "S" est installée en amont.

FUSHENG (ancien)





	P	U	H	C
FUSHENG (ancien) Embouts Plastique				
	Retention particules	3 µm	1 µm	0,01 µm
Classe de qualité - solides ⁽¹⁾	6	3	1	1*
Classe de qualité - Huile ⁽¹⁾	-	-	1	1
Media Filtrant	fibres acrylique, cellulose	micro fibres de borosilicate		charbon actif
Température de fct.[°C]	1,5 à 65	1,5 à 65	1,5 à 65	1,5 à 45
DP (élément neuf) [mbar]	10	20	80	60

	P		U		H		C	
	FUSHENG	EVOAIR	FUSHENG	EVOAIR	FUSHENG	EVOAIR	FUSHENG	EVOAIR
FFA05 P		EFS 05 P/P	FFA05 U	EFS 05 U/R	FFA05 H	EFS 05 H/S	FFA05 C	EFS 05 C/A
FFA08 P		EFS 08 P/P	FFA08 U	EFS 08 U/R	FFA08 H	EFS 08 H/S	FFA08 C	EFS 08 C/A
FFA10 P		EFS 10 P/P	FFA10 U	EFS 10 U/R	FFA10 H	EFS 10 H/S	FFA10 C	EFS 10 C/A
FFA15 P		EFS 15 P/P	FFA15 U	EFS 15 U/R	FFA15 H	EFS 15 H/S	FFA15 C	EFS 15 C/A
FFA20 P		EFS 20 P/P	FFA20 U	EFS 20 U/R	FFA20 H	EFS 20 H/S	FFA20 C	EFS 20 C/A
FFA40 P		EFS 40 P/P	FFA40 U	EFS 40 U/R	FFA40 H	EFS 40 H/S	FFA40 C	EFS 40 C/A
FFA60 P		EFS 60 P/P	FFA60 U	EFS 60 U/R	FFA60 H	EFS 60 H/S	FFA60 C	EFS 60 C/A
FFA75 P		EFS 75 P/P	FFA75 U	EFS 75 U/R	FFA75 H	EFS 75 H/S	FFA75 C	EFS 75 C/A
FFA125 P		EFS 125 P/P	FFA125 U	EFS 125 U/R	FFA125 H	EFS 125 H/S	FFA125 C	EFS 125 C/A
FFA175 P		EFS 175 P/P	FFA175 U	EFS 175 U/R	FFA175 H	EFS 175 H/S	FFA175 C	EFS 175 C/A
FFA250 P		EFS 250 P/P	FFA250 U	EFS 250 U/R	FFA250 H	EFS 250 H/S	FFA250 C	EFS 250 C/A
FFA300 P		EFS 300 P/P	FFA300 U	EFS 300 U/R	FFA300 H	EFS 300 H/S	FFA300 C	EFS 300 C/A

NOTE: * Valide si une cartouche filtrante "S" est installée en amont.

ELEMENTS FILTRANTS
 ALTERNATIFS





FUSHENG (ancien)

	P	U	H	C
FUSHENG (ancien) Embouts Aluminium				
	Retention particules	3 µm	1 µm	0,01 µm
Classe de qualité - solides ⁽¹⁾	6	3	1	1*
Classe de qualité - Huile ⁽¹⁾	-	-	1	1
Media Filtrant	fibres acrylique, cellulose	micro fibres de borosilicate		charbon actif
Température de fct.[°C]	1,5 à 65	1,5 à 65	1,5 à 65	1,5 à 45
DP (élément neuf) [mbar]	10	20	80	60

	P		U		H		C	
	FUSHENG	EVOAIR	FUSHENG	EVOAIR	FUSHENG	EVOAIR	FUSHENG	EVOAIR
FFA05 P	FFA05 P	EFS 05 P/P AL	FFA05 U	EFS 05 U/R AL	FFA05 H	EFS 05 H/S AL	FFA05 C	EFS 05 C/A AL
FFA08 P	FFA08 P	EFS 08 P/P AL	FFA08 U	EFS 08 U/R AL	FFA08 H	EFS 08 H/S AL	FFA08 C	EFS 08 C/A AL
FFA10 P	FFA10 P	EFS 10 P/P AL	FFA10 U	EFS 10 U/R AL	FFA10 H	EFS 10 H/S AL	FFA10 C	EFS 10 C/A AL
FFA15 P	FFA15 P	EFS 15 P/P AL	FFA15 U	EFS 15 U/R AL	FFA15 H	EFS 15 H/S AL	FFA15 C	EFS 15 C/A AL
FFA20 P	FFA20 P	EFS 20 P/P AL	FFA20 U	EFS 20 U/R AL	FFA20 H	EFS 20 H/S AL	FFA20 C	EFS 20 C/A AL
FFA40 P	FFA40 P	EFS 40 P/P AL	FFA40 U	EFS 40 U/R AL	FFA40 H	EFS 40 H/S AL	FFA40 C	EFS 40 C/A AL
FFA60 P	FFA60 P	EFS 60 P/P AL	FFA60 U	EFS 60 U/R AL	FFA60 H	EFS 60 H/S AL	FFA60 C	EFS 60 C/A AL
FFA75 P	FFA75 P	EFS 75 P/P AL	FFA75 U	EFS 75 U/R AL	FFA75 H	EFS 75 H/S AL	FFA75 C	EFS 75 C/A AL
FFA125 P	FFA125 P	EFS 125 P/P AL	FFA125 U	EFS 125 U/R AL	FFA125 H	EFS 125 H/S AL	FFA125 C	EFS 125 C/A AL
FFA175 P	FFA175 P	EFS 175 P/P AL	FFA175 U	EFS 175 U/R AL	FFA175 H	EFS 175 H/S AL	FFA175 C	EFS 175 C/A AL
FFA250 P	FFA250 P	EFS 250 P/P AL	FFA250 U	EFS 250 U/R AL	FFA250 H	EFS 250 H/S AL	FFA250 C	EFS 250 C/A AL
FFA300 P	FFA300 P	EFS 300 P/P AL	FFA300 U	EFS 300 U/R AL	FFA300 H	EFS 300 H/S AL	FFA300 C	EFS 300 C/A AL

NOTE: * Valide si une cartouche filtrante "S" est installée en amont.





HANKISON NGF

HANKISON NGF Embouts Plastique	SF	PF	HF	CF
				
Retention particules	3 µm	1 µm	0,01 µm	charbon actif
Classe de qualité - solides ⁽¹⁾	6	3	1	1*
Classe de qualité - Huile ⁽¹⁾	-	-	1	1
Media Filtrant	fibres acrylique, cellulose	micro fibres de borosilicate		charbon actif
Température de fct.[°C]	1,5 à 65	1,5 à 65	1,5 à 65	1,5 à 45
DP (élément neuf) [mbar]	10	20	80	60

	SF		PF		HF		CF	
	HANKISON	EVOAIR	HANKISON	EVOAIR	HANKISON	EVOAIR	HANKISON	EVOAIR
	02-SF	EHK NGF 02 SF/P	02-PF	EHK NGF 02 PF/R	02-HF	EHK NGF 02 HF/S	02-CF	EHK NGF 02 CF/A
03-SF	EHK NGF 03 SF/P	03-PF	EHK NGF 03 PF/R	03-HF	EHK NGF 03 HF/S	03-CF	EHK NGF 03 CF/A	
04-SF	EHK NGF 04 SF/P	04-PF	EHK NGF 04 PF/R	04-HF	EHK NGF 04 HF/S	04-CF	EHK NGF 04 CF/A	
06-SF	EHK NGF 06 SF/P	06-PF	EHK NGF 06 PF/R	06-HF	EHK NGF 06 HF/S	06-CF	EHK NGF 06 CF/A	
07-SF	EHK NGF 07 SF/P	07-PF	EHK NGF 07 PF/R	07-HF	EHK NGF 07 HF/S	07-CF	EHK NGF 07 CF/A	
08-SF	EHK NGF 08 SF/P	08-PF	EHK NGF 08 PF/R	08-HF	EHK NGF 08 HF/S	08-CF	EHK NGF 08 CF/A	
10-SF	EHK NGF 10 SF/P	10-PF	EHK NGF 10 PF/R	10-HF	EHK NGF 10 HF/S	10-CF	EHK NGF 10 CF/A	
11-SF	EHK NGF 11 SF/P	11-PF	EHK NGF 11 PF/R	11-HF	EHK NGF 11 HF/S	11-CF	EHK NGF 11 CF/A	
12-SF	EHK NGF 12 SF/P	12-PF	EHK NGF 12 PF/R	12-HF	EHK NGF 12 HF/S	12-CF	EHK NGF 12 CF/A	
13-SF	EHK NGF 13 SF/P	13-PF	EHK NGF 13 PF/R	13-HF	EHK NGF 13 HF/S	13-CF	EHK NGF 13 CF/A	
14-SF	EHK NGF 14 SF/P	14-PF	EHK NGF 14 PF/R	14-HF	EHK NGF 14 HF/S	14-CF	EHK NGF 14 CF/A	
15-SF	EHK NGF 15 SF/P	15-PF	EHK NGF 15 PF/R	15-HF	EHK NGF 15 HF/S	15-CF	EHK NGF 15 CF/A	
16-SF	EHK NGF 16 SF/P	16-PF	EHK NGF 16 PF/R	16-HF	EHK NGF 16 HF/S	16-CF	EHK NGF 16 CF/A	
17-SF	EHK NGF 17 SF/P	17-PF	EHK NGF 17 PF/R	17-HF	EHK NGF 17 HF/S	17-CF	EHK NGF 17 CF/A	

NOTE: * Valide si une cartouche filtrante "S" est installée en amont.





HANKISON

	E9	E7	E5	E3	E1
HANKISON Embouts Aluminium					
	Retention particules	3 µm	1 µm	0,1 µm	0,01 µm
Classe de qualité - solides ⁽¹⁾	6	3	2	1	1*
Classe de qualité - Huile ⁽¹⁾	-	-	2	1	1
Media Filtrant	fibres acrylique, cellulose		micro fibres de borosilicate		charbon actif
Température de fct.[°C]	1,5 à 65	1,5 à 65	1,5 à 65	1,5 à 65	1,5 à 45
DP (élément neuf) [mbar]	10	20	50	80	60

	E9		E7		E5		E3		E1	
	HANKISON	EVOAIR	HANKISON	EVOAIR	HANKISON	EVOAIR	HANKISON	EVOAIR	HANKISON	EVOAIR
E9-12	EHK 12 E9/P AL	EHK 12 E9/P AL	E7-12	EHK 12 E7/R AL	E5-12	EHK 12 E5/M AL	E3-12	EHK 12 E3/S AL	E1-12	EHK 12 E1/A AL
E9-16	EHK 16 E9/P AL	EHK 16 E9/P AL	E7-16	EHK 16 E7/R AL	E5-16	EHK 16 E5/M AL	E3-16	EHK 16 E3/S AL	E1-16	EHK 16 E1/A AL
E9-20	EHK 20 E9/P AL	EHK 20 E9/P AL	E7-20	EHK 20 E7/R AL	E5-20	EHK 20 E5/M AL	E3-20	EHK 20 E3/S AL	E1-20	EHK 20 E1/A AL
E9-24	EHK 24 E9/P AL	EHK 24 E9/P AL	E7-24	EHK 24 E7/R AL	E5-24	EHK 24 E5/M AL	E3-24	EHK 24 E3/S AL	E1-24	EHK 24 E1/A AL
E9-28	EHK 28 E9/P AL	EHK 28 E9/P AL	E7-28	EHK 28 E7/R AL	E5-28	EHK 28 E5/M AL	E3-28	EHK 28 E3/S AL	E1-28	EHK 28 E1/A AL
E9-32	EHK 32 E9/P AL	EHK 32 E9/P AL	E7-32	EHK 32 E7/R AL	E5-32	EHK 32 E5/M AL	E3-32	EHK 32 E3/S AL	E1-32	EHK 32 E1/A AL
E9-36	EHK 36 E9/P AL	EHK 36 E9/P AL	E7-36	EHK 36 E7/R AL	E5-36	EHK 36 E5/M AL	E3-36	EHK 36 E3/S AL	E1-36	EHK 36 E1/A AL
E9-40	EHK 40 E9/P AL	EHK 40 E9/P AL	E7-40	EHK 40 E7/R AL	E5-40	EHK 40 E5/M AL	E3-40	EHK 40 E3/S AL	E1-40	EHK 40 E1/A AL
E9-44	EHK 44 E9/P AL	EHK 44 E9/P AL	E7-44	EHK 44 E7/R AL	E5-44	EHK 44 E5/M AL	E3-44	EHK 44 E3/S AL	E1-44	EHK 44 E1/A AL
E9-48	EHK 48 E9/P AL	EHK 48 E9/P AL	E7-48	EHK 48 E7/R AL	E5-48	EHK 48 E5/M AL	E3-48	EHK 48 E3/S AL	E1-48	EHK 48 E1/A AL
E9-52	EHK 52 E9/P AL	EHK 52 E9/P AL	E7-52	EHK 52 E7/R AL	E5-52	EHK 52 E5/M AL	E3-52	EHK 52 E3/S AL	E1-52	EHK 52 E1/A AL
E9-54	EHK 54 E9/P AL	EHK 54 E9/P AL	E7-54	EHK 54 E7/R AL	E5-54	EHK 54 E5/M AL	E3-54	EHK 54 E3/S AL	E1-54	EHK 54 E1/A AL

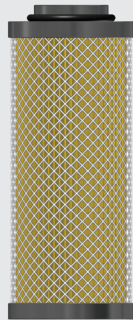
NOTE: * Valide si une cartouche filtrante "S" est installée en amont.

HIROSS (nouveau)





	Q	P	S	C
HIROSS Embouts Plastique				
Retention particules	3 µm	0,1 µm	0,01 µm	charbon actif
Classe de qualité - solides ⁽¹⁾	6	2	1	1*
Classe de qualité - Huile ⁽¹⁾	-	2	1	1
Media Filtrant	fibres acrylique, cellulose	micro fibres de borosilicate		charbon actif
Température de fct. [°C]	1,5 à 65	1,5 à 65	1,5 à 65	1,5 à 45
DP (élément neuf) [mbar]	10	50	80	60

		Q		P			S		C		
HIROSS		EVOAIR	HIROSS		EVOAIR	HIROSS		EVOAIR	HIROSS		EVOAIR
ancien	nouveau		ancien	nouveau		ancien	nouveau		ancien	nouveau	
/	005 Q	EHI 005 Q/P	/	005 P	EHI 005 P/M	/	005 S	EHI 005 S/S	/	005 C	EHI 005 C/A
004 Q 006 Q	010 Q	EHI 010 Q/P	004 P 006 P	010 P	EHI 010 P/M	004 S 006 S	010 S	EHI 010 S/S	004 C 006 C	010 C	EHI 010 C/A
007 Q 009 Q	016 Q	EHI 016 Q/P	007 P 009 P	016 P	EHI 016 P/M	007 S 009 S	016 S	EHI 016 S/S	007 C 009 C	016 C	EHI 016 C/A
015 Q 020 Q	022 Q	EHI 022 Q/P	015 P 020 P	022 P	EHI 022 P/M	015 S 020 S	022 S	EHI 022 S/S	015 C 020 C	022 C	EHI 022 C/A
024 Q	030 Q	EHI 030 Q/P	024 P	030 P	EHI 030 P/M	024 S	030 S	EHI 030 S/S	024 C	030 C	EHI 030 C/A
035 Q	045 Q	EHI 045 Q/P	035 P	045 P	EHI 045 P/M	035 S	045 S	EHI 045 S/S	035 C	045 C	EHI 045 C/A
060 Q	072 Q	EHI 072 Q/P	060 P	072 P	EHI 072 P/M	060 S	072 S	EHI 072 S/S	060 C	072 C	EHI 072 C/A
/	135 Q	EHI 135 Q/P	/	135 P	EHI 135 P/M	/	135 S	EHI 135 S/S	/	135 C	EHI 135 C/A
/	175 Q	EHI 175 Q/P	/	175 P	EHI 175 P/M	/	175 S	EHI 175 S/S	/	175 C	EHI 175 C/A
120 Q 151 Q	205 Q	EHI 205 Q/P	120 P 151 P	205 P	EHI 205 P/M	120 S 151 S	205 S	EHI 205 S/S	120 C 151 C	205 C	EHI 205 C/A
/	250 Q	EHI 250 Q/P	/	250 P	EHI 250 P/M	/	250 S	EHI 250 S/S	/	250 C	EHI 250 C/A
/	300 Q	EHI 300 Q/P	/	300 P	EHI 300 P/M	/	300 S	EHI 300 S/S	/	300 C	EHI 300 C/A
/	370 Q	EHI 370 Q/P	/	370 P	EHI 370 P/M	/	370 S	EHI 370 S/S	/	370 C	EHI 370 C/A

NOTE: * Valide si une cartouche filtrante "S" est installée en amont.

evoair ELEMENTS FILTRANTS
AIR COMPRIMÉ ALTERNATIFS





HIROSS (nouveau)

	Q	P	S	C
HIROSS Embouts Aluminium				
Retention particules	3 µm	0,1 µm	0,01 µm	charbon actif
Classe de qualité - solides ⁽¹⁾	6	2	1	1*
Classe de qualité - Huile ⁽¹⁾	-	2	1	1
Media Filtrant	fibres acrylique, cellulose	micro fibres de borosilicate		charbon actif
Température de fct. [°C]	1,5 à 65	1,5 à 65	1,5 à 65	1,5 à 45
DP (élément neuf) [mbar]	10	50	80	60

		Q		P			S		C						
		HIROSS		EVOAIR	HIROSS		EVOAIR	HIROSS		EVOAIR	HIROSS		EVOAIR		
		ancien	nouveau		ancien	nouveau		ancien	nouveau		ancien	nouveau			
/	005 Q	EH	005 Q/P AL	/	005 P	EH	005 P/M AL	/	005 S	EH	005 S/S AL	/	005 C	EH	005 C/AAL
004 Q	010 Q	EH	010 Q/P AL	004 P	010 P	EH	010 P/M AL	004 S	010 S	EH	010 S/S AL	004 C	010 C	EH	010 C/AAL
006 Q	016 Q	EH	016 Q/P AL	006 P	016 P	EH	016 P/M AL	006 S	016 S	EH	016 S/S AL	006 C	016 C	EH	016 C/AAL
007 Q	009 Q	EH	009 Q/P AL	007 P	009 P	EH	009 P/M AL	007 S	009 S	EH	009 S/S AL	007 C	009 C	EH	009 C/AAL
015 Q	022 Q	EH	022 Q/P AL	015 P	022 P	EH	022 P/M AL	015 S	022 S	EH	022 S/S AL	015 C	022 C	EH	022 C/AAL
020 Q	030 Q	EH	030 Q/P AL	020 P	030 P	EH	030 P/M AL	020 S	030 S	EH	030 S/S AL	020 C	030 C	EH	030 C/AAL
024 Q	045 Q	EH	045 Q/P AL	024 P	045 P	EH	045 P/M AL	024 S	045 S	EH	045 S/S AL	024 C	045 C	EH	045 C/AAL
035 Q	072 Q	EH	072 Q/P AL	035 P	072 P	EH	072 P/M AL	035 S	072 S	EH	072 S/S AL	035 C	072 C	EH	072 C/AAL
060 Q	135 Q	EH	135 Q/P AL	060 P	135 P	EH	135 P/M AL	060 S	135 S	EH	135 S/S AL	060 C	135 C	EH	135 C/AAL
/	175 Q	EH	175 Q/P AL	/	175 P	EH	175 P/M AL	/	175 S	EH	175 S/S AL	/	175 C	EH	175 C/AAL
/	120 Q	EH	120 Q/P AL	/	120 P	EH	120 P/M AL	/	120 S	EH	120 S/S AL	/	120 C	EH	120 C/AAL
/	151 Q	EH	151 Q/P AL	/	151 P	EH	151 P/M AL	/	151 S	EH	151 S/S AL	/	151 C	EH	151 C/AAL
/	205 Q	EH	205 Q/P AL	/	205 P	EH	205 P/M AL	/	205 S	EH	205 S/S AL	/	205 C	EH	205 C/AAL
/	250 Q	EH	250 Q/P AL	/	250 P	EH	250 P/M AL	/	250 S	EH	250 S/S AL	/	250 C	EH	250 C/AAL
/	300 Q	EH	300 Q/P AL	/	300 P	EH	300 P/M AL	/	300 S	EH	300 S/S AL	/	300 C	EH	300 C/AAL
/	370 Q	EH	370 Q/P AL	/	370 P	EH	370 P/M AL	/	370 S	EH	370 S/S AL	/	370 C	EH	370 C/AAL

NOTE: * Valide si une cartouche filtrante "S" est installée en amont.

HIROSS (ancien)





	Q	P	S	C
HIROSS Embouts Plastique				
Retention particules	3 µm	0,1 µm	0,01 µm	charbon actif
Classe de qualité - solides ⁽¹⁾	6	2	1	1*
Classe de qualité - Huile ⁽¹⁾	-	2	1	1
Media Filtrant	fibres acrylique, cellulose	micro fibres de borosilicate		charbon actif
Température de fct.[°C]	1,5 à 65	1,5 à 65	1,5 à 65	1,5 à 45
DP (élément neuf) [mbar]	10	50	80	60

	Q			P			S			C		
	HIROSS		EVOAIR	HIROSS		EVOAIR	HIROSS		EVOAIR	HIROSS		EVOAIR
	ancien	nouveau		ancien	nouveau		ancien	nouveau		ancien	nouveau	
004 Q	010 Q	EH I 004 Q/P	004 P	010 P	EH I 004 P/M	004 S	010 S	EH I 004 S/S	004 C	010 C	EH I 004 C/A	
006 Q			006 P			006 S			006 C			
007 Q	016 Q	EH I 007 Q/P	007 P	016 P	EH I 007 P/M	007 S	016 S	EH I 007 S/S	007 C	016 C	EH I 007 C/A	
009 Q			009 P			009 S			009 C			
015 Q	022 Q	EH I 015 Q/P	015 P	022 P	EH I 015 P/M	015 S	022 S	EH I 015 S/S	015 C	022 C	EH I 015 C/A	
020 Q			020 P			020 S			020 C			
024 Q	030 Q	EH I 024 Q/P	024 P	030 P	EH I 024 P/M	024 S	030 S	EH I 024 S/S	024 C	030 C	EH I 024 C/A	
035 Q	045 Q	EH I 035 Q/P	035 P	045 P	EH I 035 P/M	035 S	045 S	EH I 035 S/S	035 C	045 C	EH I 035 C/A	
060 Q	072 Q	EH I 060 Q/P	060 P	072 P	EH I 060 P/M	060 S	072 S	EH I 060 S/S	060 C	072 C	EH I 060 C/A	
090 Q	/	EH I 090 Q/P	090 P	/	EH I 090 P/M	090 S	/	EH I 090 S/S	090 C	/	EH I 090 C/A	
110 Q			110 P			110 S			110 C			
120 Q	205 Q	EH I 120 Q/P	120 P	205 P	EH I 120 P/M	120 S	205 S	EH I 120 S/S	120 C	205 C	EH I 120 C/A	
151 Q			151 P			151 S			151 C			
150 Q	/	EH I 150 Q/P	150 P	/	EH I 150 P/M	150 S	/	EH I 150 S/S	150 C	/	EH I 150 C/A	
180 Q			180 P			180 S			180 C			
200 Q	260 Q	EH I 200 Q/P	200 P	260 P	EH I 200 P/M	200 S	260 S	EH I 200 S/S	200 C	260 C	EH I 200 C/A	
240 Q	/	EH I 240 Q/P	240 P	/	EH I 240 P/M	240 S	/	EH I 240 S/S	240 C	/	EH I 240 C/A	
280 Q			280 P			280 S			280 C			

NOTE: * Valide si une cartouche filtrante "S" est installée en amont.

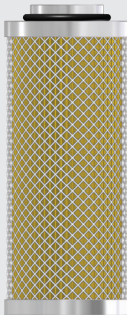
evoair ELEMENTS FILTRANTS
AIR COMPRIMÉ ALTERNATIFS



HIROSS (ancien)

	Q	P	S	C
HIROSS Embouts Aluminium				
Retention particules	3 µm	0,1 µm	0,01 µm	charbon actif
Classe de qualité - solides ⁽¹⁾	6	2	1	1*
Classe de qualité - Huile ⁽¹⁾	-	2	1	1
Media Filtrant	fibres acrylique, cellulose		micro fibres de borosilicate	
Température de fct. [°C]	1,5 à 65		1,5 à 65	
DP (élément neuf) [mbar]	10		80	

	Q			P			S			C		
	HIROSS		EVOAIR	HIROSS		EVOAIR	HIROSS		EVOAIR	HIROSS		EVOAIR
	ancien	nouveau		ancien	nouveau		ancien	nouveau		ancien	nouveau	
004 Q	010 Q	EH1 004 Q/P AL	004 P	010 P	EH1 004 P/M AL	004 S	010 S	EH1 004 S/S AL	004 C	010 C	EH1 004 C/A AL	
006 Q			006 P			006 S			006 C			
007 Q	016 Q	EH1 007 Q/P AL	007 P	016 P	EH1 007 P/M AL	007 S	016 S	EH1 007 S/S AL	007 C	016 C	EH1 007 C/A AL	
009 Q			009 P			009 S			009 C			
015 Q	022 Q	EH1 015 Q/P AL	015 P	022 P	EH1 015 P/M AL	015 S	022 S	EH1 015 S/S AL	015 C	022 C	EH1 015 C/A AL	
020 Q			020 P			020 S			020 C			
024 Q	030 Q	EH1 024 Q/P AL	024 P	030 P	EH1 024 P/M AL	024 S	030 S	EH1 024 S/S AL	024 C	030 C	EH1 024 C/A AL	
035 Q	045 Q	EH1 035 Q/P AL	035 P	045 P	EH1 035 P/M AL	035 S	045 S	EH1 035 S/S AL	035 C	045 C	EH1 035 C/A AL	
060 Q	072 Q	EH1 060 Q/P AL	060 P	072 P	EH1 060 P/M AL	060 S	072 S	EH1 060 S/S AL	060 C	072 C	EH1 060 C/A AL	
090 Q	/	EH1 090 Q/P AL	090 P	/	EH1 090 P/M AL	090 S	/	EH1 090 S/S AL	090 C	/	EH1 090 C/A AL	
110 Q			110 P			110 S			110 C			
120 Q	205 Q	EH1 120 Q/P AL	120 P	205 P	EH1 120 P/M AL	120 S	205 S	EH1 120 S/S AL	120 C	205 C	EH1 120 C/A AL	
151 Q			151 P			151 S			151 C			
150 Q	/	EH1 150 Q/P AL	150 P	/	EH1 150 P/M AL	150 S	/	EH1 150 S/S AL	150 C	/	EH1 150 C/A AL	
180 Q			180 P			180 S			180 C			
200 Q	260 Q	EH1 200 Q/P AL	200 P	260 P	EH1 200 P/M AL	200 S	260 S	EH1 200 S/S AL	200 C	260 C	EH1 200 C/A AL	
240 Q	/	EH1 240 Q/P AL	240 P	/	EH1 240 P/M AL	240 S	/	EH1 240 S/S AL	240 C	/	EH1 240 C/A AL	
280 Q			280 P			280 S			280 C			

NOTE: * Valide si une cartouche filtrante "S" est installée en amont.



INGERSOLL RAND AC

	GP	HE	AC
INGERSOLL RAND Embouts Plastique			
Retention particules	1 µm	0,01 µm	charbon actif
Classe de qualité - solides ⁽¹⁾	3	1	1*
Classe de qualité - Huile ⁽¹⁾	-	1	1
Media Filtrant	micro fibres de borosilicate		charbon actif
Température de fct. [°C]	1,5 à 65	1,5 à 65	1,5 à 45
DP (élément neuf) [mbar]	20	80	60

	GP		HE		AC	
	INGERSOLL RAND	EVOAIR	INGERSOLL RAND	EVOAIR	INGERSOLL RAND	EVOAIR
	19 GP	EIR 19 GP/R	19 HE	EIR 19 HE/S	19 AC	EIR 19 AC/A
	40 GP	EIR 40 GP/R	40 HE	EIR 40 HE/S	40 AC	EIR 40 AC/A
	64 GP	EIR 64 GP/R	64 HE	EIR 64 HE/S	64 AC	EIR 64 AC/A
	123 GP	EIR 123 GP/R	123 HE	EIR 123 HE/S	123 AC	EIR 123 AC/A
	216 GP	EIR 216 GP/R	216 HE	EIR 216 HE/S	216 AC	EIR 216 AC/A
	275 GP	EIR 275 GP/R	275 HE	EIR 275 HE/S	275 AC	EIR 275 AC/A
	350 GP	EIR 350 GP/R	350 HE	EIR 350 HE/S	350 AC	EIR 350 AC/A
	481 GP	EIR 481 GP/R	481 HE	EIR 481 HE/S	481 AC	EIR 481 AC/A
	563 GP	EIR 563 GP/R	563 HE	EIR 563 HE/S	563 AC	EIR 563 AC/A
	706 GP	EIR 706 GP/R	706 HE	EIR 706 HE/S	706 AC	EIR 706 AC/A
	850 GP	EIR 850 GP/R	850 HE	EIR 850 HE/S	850 AC	EIR 850 AC/A
	1100 GP	EIR 1100 GP/R	1100 HE	EIR 1100 HE/S	1100 AC	EIR 1100 AC/A
	1380 GP	EIR 1380 GP/R	1380 HE	EIR 1380 HE/S	1380 AC	EIR 1380 AC/A
	Flanged		Flanged		Flanged	
	424 GP	EIR 424 GP/R	424 HE	EIR 424 HE/S	424 AC	EIR 424 AC/A
	699 GP	EIR 699 GP/R	699 HE	EIR 699 HE/S	699 AC	EIR 699 AC/A
	1314 GP	EIR 1314 GP/R	1314 HE	EIR 1314 HE/S	1314 AC	EIR 1314 AC/A

NOTE: * Valide si une cartouche filtrante "S" est installée en amont.



INGERSOLL RAND F

	IG	IH	IA
INGERSOLL RAND F Embouts Plastique			
Retention particules	1 µm	0,01 µm	charbon actif
Classe de qualité - solides ⁽¹⁾	3	1	1*
Classe de qualité - Huile ⁽¹⁾	-	1	1
Media Filtrant	micro fibres de borosilicate		charbon actif
Température de fct. [°C]	1,5 à 65	1,5 à 65	1,5 à 45
DP (élément neuf) [mbar]	20	80	60

	IG		IH		IA	
	INGERSOLL RAND	EVOAIR	INGERSOLL RAND	EVOAIR	INGERSOLL RAND	EVOAIR
	F35 IG	EIR F35 IG/R	F35 IH	EIR F35 IH/S	F35 IA	EIR F35 IA/A
	F71 IG	EIR F71 IG/R	F71 IH	EIR F71 IH/S	F71 IA	EIR F71 IA/A
	F108 IG	EIR F108 IG/R	F108 IH	EIR F108 IH/S	F108 IA	EIR F108 IA/A
	F144 IG	EIR F144 IG/R	F144 IH	EIR F144 IH/S	F144 IA	EIR F144 IA/A
	F178 IG	EIR F178 IG/R	F178 IH	EIR F178 IH/S	F178 IA	EIR F178 IA/A
	F212 IG	EIR F212 IG/R	F212 IH	EIR F212 IH/S	F212 IA	EIR F212 IA/A
	F395 IG	EIR F395 IG/R	F395 IH	EIR F395 IH/S	F395 IA	EIR F395 IA/A
	F424 IG	EIR F424 IG/R	F424 IH	EIR F424 IH/S	F424 IA	EIR F424 IA/A
	F577 IG	EIR F577 IG/R	F577 IH	EIR F577 IH/S	F577 IA	EIR F577 IA/A
	F791 IG	EIR F791 IG/R	F791 IH	EIR F791 IH/S	F791 IA	EIR F791 IA/A
	F985 IG	EIR F985 IG/R	F985 IH	EIR F985 IH/S	F985 IA	EIR F985 IA/A
	F1155 IG	EIR F1155 IG/R	F1155 IH	EIR F1155 IH/S	F1155 IA	EIR F1155 IA/A
	F1529 IG	EIR F1529 IG/R	F1529 IH	EIR F1529 IH/S	F1529 IA	EIR F1529 IA/A
	F1817 IG	EIR F1817 IG/R	F1817 IH	EIR F1817 IH/S	F1817 IA	EIR F1817 IA/A
	F2378 IG	EIR F2378 IG/R	F2124 IH	EIR F2124 IH/S	F2378 IA	EIR F2378 IA/A

NOTE: * Valide si une cartouche filtrante "S" est installée en amont.

INGERSOLL RAND FA

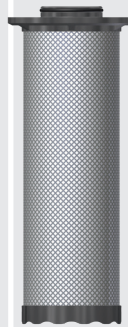



	IG	IH	IA
INGERSOLL RAND FA Embouts Plastique			
	Retention particules	1 µm	0,01 µm
Classe de qualité - solides ⁽¹⁾	3	1	1*
Classe de qualité - Huile ⁽¹⁾	-	1	1
Media Filtrant	micro fibres de borosilicate		charbon actif
Température de fct. [°C]	1,5 à 65	1,5 à 65	1,5 à 45
DP (élément neuf) [mbar]	20	80	60

	IG		IH		IA	
	INGERSOLL RAND	EVOAIR	INGERSOLL RAND	EVOAIR	INGERSOLL RAND	EVOAIR
FA30 IG	EIR FA30 IG/R	FA30 IH	EIR FA30 IH/S	FA30 IA	EIR FA30 IA/A	
FA40 IG	EIR FA40 IG/R	FA40 IH	EIR FA40 IH/S	FA40 IA	EIR FA40 IA/A	
FA75 IG	EIR FA75 IG/R	FA75 IH	EIR FA75 IH/S	FA75 IA	EIR FA75 IA/A	
FA110 IG	EIR FA110 IG/R	FA110 IH	EIR FA110 IH/S	FA110 IA	EIR FA110 IA/A	
FA150 IG	EIR FA150 IG/R	FA150 IH	EIR FA150 IH/S	FA150 IA	EIR FA150 IA/A	
FA190 IG	EIR FA190 IG/R	FA190 IH	EIR FA190 IH/S	FA190 IA	EIR FA190 IA/A	
FA230 IG	EIR FA230 IG/R	FA230 IH	EIR FA230 IH/S	FA230 IA	EIR FA230 IA/A	
FA400 IG	EIR FA400 IG/R	FA400 IH	EIR FA400 IH/S	FA400 IA	EIR FA400 IA/A	
FA490 IG	EIR FA490 IG/R	FA490 IH	EIR FA490 IH/S	FA490 IA	EIR FA490 IA/A	
FA600 IG	EIR FA600 IG/R	FA600 IH	EIR FA600 IH/S	FA600 IA	EIR FA600 IA/A	
FA800 IG	EIR FA800 IG/R	FA800 IH	EIR FA800 IH/S	FA800 IA	EIR FA800 IA/A	
FA1000 IG	EIR FA1000 IG/R	FA1000 IH	EIR FA1000 IH/S	FA1000 IA	EIR FA1000 IA/A	
FA1200 IG	EIR FA1200 IG/R	FA1200 IH	EIR FA1200 IH/S	FA1200 IA	EIR FA1200 IA/A	
FA1560 IG	EIR FA1560 IG/R	FA1560 IH	EIR FA1560 IH/S	FA1560 IA	EIR FA1560 IA/A	
FA1830 IG	EIR FA1830 IG/R	FA1830 IH	EIR FA1830 IH/S	FA1830 IA	EIR FA1830 IA/A	
FA2300 IG	EIR FA2300 IG/R	FA2300 IH	EIR FA2300 IH/S	FA2300 IA	EIR FA2300 IA/A	
FA2700 IG	EIR FA2700 IG/R	FA2700 IH	EIR FA2700 IH/S	FA2700 IA	EIR FA2700 IA/A	

NOTE: * Valide si une cartouche filtrante "S" est installée en amont.

ELEMENTS FILTRANTS
 ALTERNATIFS





KAESER (nouveau)

	KD	KB	KBE	KE	KA
KAESER (nouveau) Embouts Plastique					
	Retention particules	3 µm	1 µm	0,1 µm	0,01 µm
Classe de qualité - solides ⁽¹⁾	6	3	2	1	1*
Classe de qualité - Huile ⁽¹⁾	-	-	2	1	1
Media Filtrant	fibres acrylique, cellulose		micro fibres de borosilicate		charbon actif
Température de fct.[°C]	1,5 à 65	1,5 à 65	1,5 à 65	1,5 à 65	1,5 à 45
DP (élément neuf) [mbar]	10	20	50	80	60

	KD		KB		KBE		KE		KA	
	KAESER	EVOAIR	KAESER	EVOAIR	KAESER	EVOAIR	KAESER	EVOAIR	KAESER	EVOAIR
F6 KD	EKA F6 KD/P	F6 KB	EKA F6 KB/R	F6 KBE	EKA F6 KBE/M	F6 KE	EKA F6 KE/S	F6 KA	EKA F6 KA/A	
F9 KD	EKA F9 KD/P	F9 KB	EKA F9 KB/R	F9 KBE	EKA F9 KBE/M	F9 KE	EKA F9 KE/S	F9 KA	EKA F9 KA/A	
F16 KD	EKA F16 KD/P	F16 KB	EKA F16 KB/R	F16 KBE	EKA F16 KBE/M	F16 KE	EKA F16 KE/S	F16 KA	EKA F16 KA/A	
F22 KD	EKA F22 KD/P	F22 KB	EKA F22 KB/R	F22 KBE	EKA F22 KBE/M	F22 KE	EKA F22 KE/S	F22 KA	EKA F22 KA/A	
F26 KD	EKA F26 KD/P	F26 KB	EKA F26 KB/R	F26 KBE	EKA F26 KBE/M	F26 KE	EKA F26 KE/S	F26 KA	EKA F26 KA/A	
F46 KD	EKA F46 KD/P	F46 KB	EKA F46 KB/R	F46 KBE	EKA F46 KBE/M	F46 KE	EKA F46 KE/S	F46 KA	EKA F46 KA/A	
F83 KD	EKA F83 KD/P	F83 KB	EKA F83 KB/R	F83 KBE	EKA F83 KBE/M	F83 KE	EKA F83 KE/S	F83 KA	EKA F83 KA/A	
F110 KD	EKA F110 KD/P	F110 KB	EKA F110 KB/R	F110 KBE	EKA F110 KBE/M	F110 KE	EKA F110 KE/S	F110 KA	EKA F110 KA/A	
F142 KD	EKA F142 KD/P	F142 KB	EKA F142 KB/R	F142 KBE	EKA F142 KBE/M	F142 KE	EKA F142 KE/S	F142 KA	EKA F142 KA/A	

NOTE: * Valide si une cartouche filtrante "S" est installée en amont.

KAESER (ancien)



	E-B	E-C	E-E	E-F	E-G
KAESER (ancien) Embouts Aluminium					
	Retention particules	3 µm	1 µm	0,1 µm	0,01 µm
Classe de qualité - solides ⁽¹⁾	6	3	2	1	1*
Classe de qualité - Huile ⁽¹⁾	-	-	2	1	1
Media Filtrant	fibres acrylique, cellulose		micro fibres de borosilicate		charbon actif
Température de fct.[°C]	1,5 à 65	1,5 à 65	1,5 à 65	1,5 à 65	1,5 à 45
DP (élément neuf) [mbar]	10	20	50	80	60

	E-B		E-C		E-E		E-F		E-G	
	KAESER	EVOAIR	KAESER	EVOAIR	KAESER	EVOAIR	KAESER	EVOAIR	KAESER	EVOAIR
E-B-6	EKA 6 E-B/P AL		E-C-6	EKA 6 E-C/R AL	E-E-6	EKA 6 E-E/M AL	E-F-6	EKA 6 E-F/S AL	E-G-6	EKA 6 E-G/A AL
E-B-10	EKA 10 E-B/P AL		E-C-10	EKA 10 E-C/R AL	E-E-10	EKA 10 E-E/M AL	E-F-10	EKA 10 E-F/S AL	E-G-10	EKA 10 E-G/A AL
E-B-18	EKA 18 E-B/P AL		E-C-18	EKA 18 E-C/R AL	E-E-18	EKA 18 E-E/M AL	E-F-18	EKA 18 E-F/S AL	E-G-18	EKA 18 E-G/A AL
E-B-28	EKA 28 E-B/P AL		E-C-28	EKA 28 E-C/R AL	E-E-28	EKA 28 E-E/M AL	E-F-28	EKA 28 E-F/S AL	E-G-28	EKA 28 E-G/A AL
E-B-48	EKA 48 E-B/P AL		E-C-48	EKA 48 E-C/R AL	E-E-48	EKA 48 E-E/M AL	E-F-48	EKA 48 E-F/S AL	E-G-48	EKA 48 E-G/A AL
E-B-71	EKA 71 E-B/P AL		E-C-71	EKA 71 E-C/R AL	E-E-71	EKA 71 E-E/M AL	E-F-71	EKA 71 E-F/S AL	E-G-71	EKA 71 E-G/A AL
E-B-107	EKA 107 E-B/P AL		E-C-107	EKA 107 E-C/R AL	E-E-107	EKA 107 E-E/M AL	E-F-107	EKA 107 E-F/S AL	E-G-107	EKA 107 E-G/A AL
E-B-138	EKA 138 E-B/P AL		E-C-138	EKA 138 E-C/R AL	E-E-138	EKA 138 E-E/M AL	E-F-138	EKA 138 E-F/S AL	E-G-138	EKA 138 E-G/A AL
E-B-177	EKA 177 E-B/P AL		E-C-177	EKA 177 E-C/R AL	E-E-177	EKA 177 E-E/M AL	E-F-177	EKA 177 E-F/S AL	E-G-177	EKA 177 E-G/A AL
E-B-221	EKA 221 E-B/P AL		E-C-221	EKA 221 E-C/R AL	E-E-221	EKA 221 E-E/M AL	E-F-221	EKA 221 E-F/S AL	E-G-221	EKA 221 E-G/A AL
E-B-185	EKA 185 E-B/P AL		E-C-185	EKA 185 E-C/R AL	E-E-185	EKA 185 E-E/M AL	E-F-185	EKA 185 E-F/S AL	E-G-185	EKA 185 E-G/A AL
E-B-283	EKA 283 E-B/P AL		E-C-283	EKA 283 E-C/R AL	E-E-283	EKA 283 E-E/M AL	E-F-283	EKA 283 E-F/S AL	E-G-283	EKA 283 E-G/A AL

NOTE: * Valide si une cartouche filtrante "S" est installée en amont.

ELEMENTS FILTRANTS
 ALTERNATIFS



KNOCKS

KNOCKS Embouts Aluminium	V	X	A
			
Retention particules	0,1 µm	0,01 µm	charbon actif
Classe de qualité - solides ⁽¹⁾	2	1	1*
Classe de qualité - Huile ⁽¹⁾	2	1	1
Media Filtrant	micro fibres de borosilicate		charbon actif
Température de fct. [°C]	1,5 à 65	1,5 à 65	1,5 à 45
DP (élément neuf) [mbar]	50	80	60

KNOCKS	V		X		A	
	KNOCKS	EVOAIR	KNOCKS	EVOAIR	KNOCKS	EVOAIR
V 23/35	EKN 2335 V/M AL	X 23/35	EKN 2335 X/S AL	-	EKN 2335 A/A AL	
V 23/40	EKN 2340 V/M AL	-	-	-	-	
V 23/60	EKN 2360 V/M AL	X 23/60	EKN 2360 X/S AL	A 23/60	EKN 2360 A/A AL	
-	-	X 23/70	EKN 2370 X/S AL	A 23/70	EKN 2370 A/A AL	
-	-	-	-	A 23/80	EKN 2380 A/A AL	
V 38/60	EKN 3860 V/M AL	X 38/60	EKN 3860 X/S AL	-	-	
-	-	-	-	A 38/90	EKN 3890 A/A AL	
V 38/100	EKN 38100 V/M AL	X 38/100	EKN 38100 X/S AL	-	-	
V 38/185	EKN 38185 V/M AL	X 38/185	EKN 38185 X/S AL	A 38/185	EKN 38185 A/A AL	
V 61/130	EKN 61130 V/M AL	X 61/130	EKN 61130 X/S AL	A 61/130	EKN 61130 A/A AL	
V 61/230	EKN 61230 V/M AL	X 61/230	EKN 61230 X/S AL	A 61/230	EKN 61230 A/A AL	

NOTE: * Valide si une cartouche filtrante "S" est installée en amont.

KOBELCO





KOBELCO Embouts Plastique	KO	KA	KCS
			
Retention particules	0,1 µm	0,01 µm	charbon actif
Classe de qualité - solides ⁽¹⁾	2	1	1*
Classe de qualité - Huile ⁽¹⁾	2	1	1
Media Filtrant	micro fibres de borosilicate		charbon actif
Température de fct.[°C]	1,5 à 65	1,5 à 65	1,5 à 45
DP (élément neuf) [mbar]	50	80	60

	KO		KA		KCS	
	KOBELCO	EVOAIR	KOBELCO	EVOAIR	KOBELCO	EVOAIR
	KO 060	EKO 060 KO/M	KA 060	EKO 060 KA/S	KCS 060	EKO 060 KCS/A
	KO 120	EKO 120 KO/M	KA 120	EKO 120 KA/S	KCS 120	EKO 120 KCS/A
	KO 180	EKO 180 KO/M	KA 180	EKO 180 KA/S	KCS 180	EKO 180 KCS/A
	KO 370	EKO 370 KO/M	KA 370	EKO 370 KA/S	KCS 370	EKO 370 KCS/A
	KO 660	EKO 660 KO/M	KA 660	EKO 660 KA/S	KCS 660	EKO 660 KCS/A
	KO 960	EKO 960 KO/M	KA 960	EKO 960 KA/S	KCS 960	EKO 960 KCS/A
	KO 1320	EKO 1320 KO/M	KA 1320	EKO 1320 KA/S	KCS 1320	EKO 1320 KCS/A
	KO 1980	EKO 1980 KO/M	KA 1980	EKO 1980 KA/S	KCS 1980	EKO 1980 KCS/A
	KO 2580	EKO 2580 KO/M	KA 2580	EKO 2580 KA/S	KCS 2580	EKO 2580 KCS/A

NOTE: * Valide si une cartouche filtrante "S" est installée en amont.

ELEMENTS FILTRANTS ALTERNATIFS





KSI

	FF5	MFO	SMA	CA
KSI Embouts Plastique				
Retention particules	3 µm	1 µm	0,01 µm	charbon actif
Classe de qualité - solides ⁽¹⁾	6	3	1	1*
Classe de qualité - Huile ⁽¹⁾	-	-	1	1
Media Filtrant	fibres acrylique, cellulose	micro fibres de borosilicate		charbon actif
Température de fct.[°C]	1,5 à 65	1,5 à 65	1,5 à 65	1,5 à 45
DP (élément neuf) [mbar]	10	20	80	60

	FF5		MFO		SMA		CA	
	KSI	EVOAIR	KSI	EVOAIR	KSI	EVOAIR	KSI	EVOAIR
FE3711 FF5	EKS 3711 FF5/P		FE3711 MFO	EKS 3711 MFO/R	FE3711 SMA	EKS 3711 SMA/S	FE3711 CA	EKS 3711 CA/A
FE5111 FF5	EKS 5111 FF5/P		FE5111 MFO	EKS 5111 MFO/R	FE5111 SMA	EKS 5111 SMA/S	FE5111 CA	EKS 5111 CA/A
FE7111 FF5	EKS 7111 FF5/P		FE7111 MFO	EKS 7111 MFO/R	FE7111 SMA	EKS 7111 SMA/S	FE7111 CA	EKS 7111 CA/A
FE7311 FF5	EKS 7311 FF5/P		FE7311 MFO	EKS 7311 MFO/R	FE7311 SMA	EKS 7311 SMA/S	FE7311 CA	EKS 7311 CA/A
FE7411 FF5	EKS 7411 FF5/P		FE7411 MFO	EKS 7411 MFO/R	FE7411 SMA	EKS 7411 SMA/S	FE7411 CA	EKS 7411 CA/A
FE8501 FF5	EKS 8501 FF5/P		FE8501 MFO	EKS 8501 MFO/R	FE8501 SMA	EKS 8501 SMA/S	FE8501 CA	EKS 8501 CA/A
FE8601 FF5	EKS 8601 FF5/P		FE8601 MFO	EKS 8601 MFO/R	FE8601 SMA	EKS 8601 SMA/S	FE8601 CA	EKS 8601 CA/A
FE8701 FF5	EKS 8701 FF5/P		FE8701 MFO	EKS 8701 MFO/R	FE8701 SMA	EKS 8701 SMA/S	FE8701 CA	EKS 8701 CA/A
FE8901 FF5	EKS 8901 FF5/P		FE8901 MFO	EKS 8901 MFO/R	FE8901 SMA	EKS 8901 SMA/S	FE8901 CA	EKS 8901 CA/A

NOTE: * Valide si une cartouche filtrante "S" est installée en amont.

MARK (nouveau)





	P	G	C	V
MARK (nouveau) Embouts Plastique				
	Retention particules	1 µm	0,1 µm	0,01 µm
Classe de qualité - solides ⁽¹⁾	3	2	1	1*
Classe de qualité - Huile ⁽¹⁾	-	2	1	1
Media Filtrant	micro fibres de borosilicate			charbon actif
Température de fct. [°C]	1,5 à 65	1,5 à 65	1,5 à 65	1,5 à 45
DP (élément neuf) [mbar]	20	50	80	60

	P		G		C		V	
	MARK	EVOAIR	MARK	EVOAIR	MARK	EVOAIR	MARK	EVOAIR
FILTER 7	EMA 7 P/R	FILTER 7	EMA 7 G/M	FILTER 7	EMA 7 C/S	FILTER 7	EMA 7 V/A	
FILTER 15	EMA 15 P/R	FILTER 15	EMA 15 G/M	FILTER 15	EMA 15 C/S	FILTER 15	EMA 15 V/A	
FILTER 21	EMA 21 P/R	FILTER 21	EMA 21 G/M	FILTER 21	EMA 21 C/S	FILTER 21	EMA 21 V/A	
FILTER 30	EMA 30 P/R	FILTER 30	EMA 30 G/M	FILTER 30	EMA 30 C/S	FILTER 30	EMA 30 V/A	
FILTER 48	EMA 48 P/R	FILTER 48	EMA 48 G/M	FILTER 48	EMA 48 C/S	FILTER 48	EMA 48 V/A	
FILTER 84	EMA 84 P/R	FILTER 84	EMA 84 G/M	FILTER 84	EMA 84 C/S	FILTER 84	EMA 84 V/A	
FILTER 114	EMA 114 P/R	FILTER 114	EMA 114 G/M	FILTER 114	EMA 114 C/S	FILTER 114	EMA 114 V/A	
FILTER 156	EMA 156 P/R	FILTER 156	EMA 156 G/M	FILTER 156	EMA 156 C/S	FILTER 156	EMA 156 V/A	
FILTER 216	EMA 216 P/R	FILTER 216	EMA 216 G/M	FILTER 216	EMA 216 C/S	FILTER 216	EMA 216 V/A	
FILTER 315	EMA 315 P/R	FILTER 315	EMA 315 G/M	FILTER 315	EMA 315 C/S	FILTER 315	EMA 315 V/A	
FILTER 405	EMA 405 P/R	FILTER 405	EMA 405 G/M	FILTER 405	EMA 405 C/S	FILTER 405	EMA 405 V/A	

NOTE: * Valide si une cartouche filtrante "S" est installée en amont.upstream.

ELEMENTS FILTRANTS ALTERNATIFS





MARK (ancien)

	MBP	MBM	MBS	MBA
MARK (ancien) Embouts Plastique				
Retention particules	3 µm	0,1 µm	0,01 µm	charbon actif
Classe de qualité - solides ⁽¹⁾	6	2	1	1*
Classe de qualité - Huile ⁽¹⁾	-	2	1	1
Media Filtrant	fibres acrylique, cellulose	micro fibres de borosilicate		charbon actif
Température de fct. [°C]	1,5 à 65	1,5 à 65	1,5 à 65	1,5 à 45
DP (élément neuf) [mbar]	10	50	80	60

	MBP		MBM		MBS		MBA	
	MARK	EVOAIR	MARK	EVOAIR	MARK	EVOAIR	MARK	EVOAIR
MBP 10		EMA 10 MBP/P	MBM 10	EMA 10 MBM/M	MBS 10	EMA 10 MBS/S	MBA 10	EMA 10 MBA/A
MBP 13		EMA 13 MBP/P	MBM 13	EMA 13 MBM/M	MBS 13	EMA 13 MBS/S	MBA 13	EMA 13 MBA/A
MBP 20		EMA 20 MBP/P	MBM 20	EMA 20 MBM/M	MBS 20	EMA 20 MBS/S	MBA 20	EMA 20 MBA/A
MBP 33		EMA 33 MBP/P	MBM 33	EMA 33 MBM/M	MBS 33	EMA 33 MBS/S	MBA 33	EMA 33 MBA/A
MBP 60		EMA 60 MBP/P	MBM 60	EMA 60 MBM/M	MBS 60	EMA 60 MBS/S	MBA 60	EMA 60 MBA/A
MBP 85		EMA 85 MBP/P	MBM 85	EMA 85 MBM/M	MBS 85	EMA 85 MBS/S	MBA 85	EMA 85 MBA/A
MBP 130		EMA 130 MBP/P	MBM 130	EMA 130 MBM/M	MBS 130	EMA 130 MBS/S	MBA 130	EMA 130 MBA/A
MBP 170		EMA 170 MBP/P	MBM 170	EMA 170 MBM/M	MBS 170	EMA 170 MBS/S	MBA 170	EMA 170 MBA/A
MBP 250		EMA 250 MBP/P	MBM 250	EMA 250 MBM/M	MBS 250	EMA 250 MBS/S	MBA 250	EMA 250 MBA/A
MBP 400		EMA 400 MBP/P	MBM 400	EMA 400 MBM/M	MBS 400	EMA 400 MBS/S	MBA 400	EMA 400 MBA/A

NOTE: * Valide si une cartouche filtrante "S" est installée en amont.

MATTEI OMAT





MATTEI OMAT Embouts Plastique	C3	C2	C1	CC
				
Retention particules	3 µm	0,1 µm	0,01 µm	charbon actif
Classe de qualité - solides ⁽¹⁾	6	2	1	1*
Classe de qualité - Huile ⁽¹⁾	-	2	1	1
Media Filtrant	fibres acrylique, cellulose	micro fibres de borosilicate		charbon actif
Température de fct.[°C]	1,5 à 65	1,5 à 65	1,5 à 65	1,5 à 45
DP (élément neuf) [mbar]	10	50	80	60

	C3		C2		C1		CC	
	MATTEI OMAT	EVOAIR	MATTEI OMAT	EVOAIR	MATTEI OMAT	EVOAIR	MATTEI OMAT	EVOAIR
	0005 C3	EMAT 0005 C3/P	0005 C2	EMAT 0005 C2/M	0005 C1	EMAT 0005 C1/S	0005 CC	EMAT 0005 CC/A
	0010 C3	EMAT 0010 C3/P	0010 C2	EMAT 0010 C2/M	0010 C1	EMAT 0010 C1/S	0010 CC	EMAT 0010 CC/A
	0018 C3	EMAT 0018 C3/P	0018 C2	EMAT 0018 C2/M	0018 C1	EMAT 0018 C1/S	0018 CC	EMAT 0018 CC/A
	0030 C3	EMAT 0030 C3/P	0030 C2	EMAT 0030 C2/M	0030 C1	EMAT 0030 C1/S	0030 CC	EMAT 0030 CC/A
	0035 C3	EMAT 0035 C3/P	0035 C2	EMAT 0035 C2/M	0035 C1	EMAT 0035 C1/S	0035 CC	EMAT 0035 CC/A
	0050 C3	EMAT 0050 C3/P	0050 C2	EMAT 0050 C2/M	0050 C1	EMAT 0050 C1/S	0050 CC	EMAT 0050 CC/A
	0072 C3	EMAT 0072 C3/P	0072 C2	EMAT 0072 C2/M	0072 C1	EMAT 0072 C1/S	0072 CC	EMAT 0072 CC/A
	0095 C3	EMAT 0095 C3/P	0095 C2	EMAT 0095 C2/M	0095 C1	EMAT 0095 C1/S	0095 CC	EMAT 0095 CC/A
	0125 C3	EMAT 0125 C3/P	0125 C2	EMAT 0125 C2/M	0125 C1	EMAT 0125 C1/S	0125 CC	EMAT 0125 CC/A
	0165 C3	EMAT 0165 C3/P	0165 C2	EMAT 0165 C2/M	0165 C1	EMAT 0165 C1/S	0165 CC	EMAT 0165 CC/A
	0190 C3	EMAT 0190 C3/P	0190 C2	EMAT 0190 C2/M	0190 C1	EMAT 0190 C1/S	0190 CC	EMAT 0190 CC/A
	0220 C3	EMAT 0220 C3/P	0220 C2	EMAT 0220 C2/M	0220 C1	EMAT 0220 C1/S	0220 CC	EMAT 0220 CC/A
	0280 C3	EMAT 0280 C3/P	0280 C2	EMAT 0280 C2/M	0280 C1	EMAT 0280 C1/S	0280 CC	EMAT 0280 CC/A
	0350 C3	EMAT 0350 C3/P	0350 C2	EMAT 0350 C2/M	0350 C1	EMAT 0350 C1/S	0350 CC	EMAT 0350 CC/A
	0440 C3	EMAT 0440 C3/P	0440 C2	EMAT 0440 C2/M	0440 C1	EMAT 0440 C1/S	-	-

NOTE: * Valide si une cartouche filtrante "S" est installée en amont.

ELEMENTS FILTRANTS
 ALTERNATIFS





MAUGUIERE (nouveau)

	P	G	C	V
MAUGUIERE (nouveau) Embouts Plastique				
	Retention particules	1 µm	0,1 µm	0,01 µm
Classe de qualité - solides ⁽¹⁾	3	2	1	1*
Classe de qualité - Huile ⁽¹⁾	-	2	1	1
Media Filtrant	micro fibres de borosilicate			charbon actif
Température de fct. [°C]	1,5 à 65	1,5 à 65	1,5 à 65	1,5 à 45
DP (élément neuf) [mbar]	20	50	80	60

	P		G		C		V	
	MAUGUIERE	EVOAIR	MAUGUIERE	EVOAIR	MAUGUIERE	EVOAIR	MAUGUIERE	EVOAIR
FILTER 7	EMG 7 P/R		FILTER 7	EMG 7 G/M	FILTER 7	EMG 7 C/S	FILTER 7	EMG 7 V/A
FILTER 15	EMG 15 P/R		FILTER 15	EMG 15 G/M	FILTER 15	EMG 15 C/S	FILTER 15	EMG 15 V/A
FILTER 21	EMG 21 P/R		FILTER 21	EMG 21 G/M	FILTER 21	EMG 21 C/S	FILTER 21	EMG 21 V/A
FILTER 30	EMG 30 P/R		FILTER 30	EMG 30 G/M	FILTER 30	EMG 30 C/S	FILTER 30	EMG 30 V/A
FILTER 48	EMG 48 P/R		FILTER 48	EMG 48 G/M	FILTER 48	EMG 48 C/S	FILTER 48	EMG 48 V/A
FILTER 84	EMG 84 P/R		FILTER 84	EMG 84 G/M	FILTER 84	EMG 84 C/S	FILTER 84	EMG 84 V/A
FILTER 114	EMG 114 P/R		FILTER 114	EMG 114 G/M	FILTER 114	EMG 114 C/S	FILTER 114	EMG 114 V/A
FILTER 156	EMG 156 P/R		FILTER 156	EMG 156 G/M	FILTER 156	EMG 156 C/S	FILTER 156	EMG 156 V/A
FILTER 216	EMG 216 P/R		FILTER 216	EMG 216 G/M	FILTER 216	EMG 216 C/S	FILTER 216	EMG 216 V/A
FILTER 315	EMG 315 P/R		FILTER 315	EMG 315 G/M	FILTER 315	EMG 315 C/S	FILTER 315	EMG 315 V/A
FILTER 405	EMG 405 P/R		FILTER 405	EMG 405 G/M	FILTER 405	EMG 405 C/S	FILTER 405	EMG 405 V/A

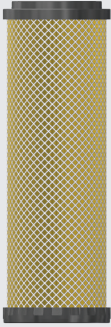
NOTE: * Valide si une cartouche filtrante "S" est installée en amont.

MAUGUIERE (ancien)

	MBP	MBM	MBS	MBA
MAUGUIERE (ancien) Embouts Plastique				
	Retention particules	3 µm	0,1 µm	0,01 µm
Classe de qualité - solides ⁽¹⁾	6	2	1	1*
Classe de qualité - Huile ⁽¹⁾	-	2	1	1
Media Filtrant	fibres acrylique, cellulose	micro fibres de borosilicate		charbon actif
Température de fct. [°C]	1,5 à 65	1,5 à 65	1,5 à 65	1,5 à 45
DP (élément neuf) [mbar]	10	50	80	60





	MBP		MBM		MBS		MBA	
	MAUGUIERE	EVOAIR	MAUGUIERE	EVOAIR	MAUGUIERE	EVOAIR	MAUGUIERE	EVOAIR
MBP 10	EMG 10 MBP/P		MBM 10	EMG 10 MBM/M	MBS 10	EMG 10 MBS/S	MBA 10	EMG 10 MBA/A
MBP 13	EMG 13 MBP/P		MBM 13	EMG 13 MBM/M	MBS 13	EMG 13 MBS/S	MBA 13	EMG 13 MBA/A
MBP 20	EMG 20 MBP/P		MBM 20	EMG 20 MBM/M	MBS 20	EMG 20 MBS/S	MBA 20	EMG 20 MBA/A
MBP 33	EMG 33 MBP/P		MBM 33	EMG 33 MBM/M	MBS 33	EMG 33 MBS/S	MBA 33	EMG 33 MBA/A
MBP 60	EMG 60 MBP/P		MBM 60	EMG 60 MBM/M	MBS 60	EMG 60 MBS/S	MBA 60	EMG 60 MBA/A
MBP 85	EMG 85 MBP/P		MBM 85	EMG 85 MBM/M	MBS 85	EMG 85 MBS/S	MBA 85	EMG 85 MBA/A
MBP 130	EMG 130 MBP/P		MBM 130	EMG 130 MBM/M	MBS 130	EMG 130 MBS/S	MBA 130	EMG 130 MBA/A
MBP 170	EMG 170 MBP/P		MBM 170	EMG 170 MBM/M	MBS 170	EMG 170 MBS/S	MBA 170	EMG 170 MBA/A
MBP 250	EMG 250 MBP/P		MBM 250	EMG 250 MBM/M	MBS 250	EMG 250 MBS/S	MBA 250	EMG 250 MBA/A
MBP 400	EMG 400 MBP/P		MBM 400	EMG 400 MBM/M	MBS 400	EMG 400 MBS/S	MBA 400	EMG 400 MBA/A

NOTE: * Valide si une cartouche filtrante "S" est installée en amont.

ELEMENTS FILTRANTS ALTERNATIFS

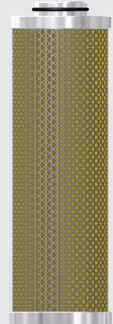
STERILE



MICROPOR G

	P	X	Y	A
MIKROPOR G Embouts Aluminium				
Retention particules	3 µm	1 µm	0,01 µm	charbon actif
Classe de qualité - solides ⁽¹⁾	3	3	1	1*
Classe de qualité - Huile ⁽¹⁾	-	-	1	1
Media Filtrant	fibres acrylique, cellulose	micro fibres de borosilicate		charbon actif
Température de fct. [°C]	1,5 à 65	1,5 à 65	1,5 à 65	1,5 à 45
DP (élément neuf) [mbar]	20	20	80	60

	P		X		Y		A	
	MIKROPOR	EVOAIR	MIKROPOR	EVOAIR	MIKROPOR	EVOAIR	MIKROPOR	EVOAIR
G24 P		EMP M24 P/P AL	G24 X	EMP M24 X/R AL	G24 Y	EMP M24 Y/S AL	G24 A	EMP M24 A/A AL
G48 P		EMP M48 P/P AL	G48 X	EMP M48 X/R AL	G48 Y	EMP M48 Y/S AL	G48 A	EMP M48 A/A AL
G25 P		EMP M25 P/P AL	G25 X	EMP M25 X/R AL	G25 Y	EMP M25 Y/S AL	G25 A	EMP M25 A/A AL
G50 P		EMP M50 P/P AL	G50 X	EMP M50 X/R AL	G50 Y	EMP M50 Y/S AL	G50 A	EMP M50 A/A AL
G100 P		EMP M100 P/P AL	G100 X	EMP M100 X/R AL	G100 Y	EMP M100 Y/S AL	G100 A	EMP M100 A/A AL
G150 P		EMP M150 P/P AL	G150 X	EMP M150 X/R AL	G150 Y	EMP M150 Y/S AL	G150 A	EMP M150 A/A AL
G200 P		EMP M200 P/P AL	G200 X	EMP M200 X/R AL	G200 Y	EMP M200 Y/S AL	G200 A	EMP M200 A/A AL
G250 P		EMP M250 P/P AL	G250 X	EMP M250 X/R AL	G250 Y	EMP M250 Y/S AL	G250 A	EMP M250 A/A AL
G300 P		EMP M300 P/P AL	G300 X	EMP M300 X/R AL	G300 Y	EMP M300 Y/S AL	G300 A	EMP M300 A/A AL
G500 P		EMP M500 P/P AL	G500 X	EMP M500 X/R AL	G500 Y	EMP M500 Y/S AL	G500 A	EMP M500 A/A AL
G600 P		EMP M600 P/P AL	G600 X	EMP M600 X/R AL	G600 Y	EMP M600 Y/S AL	G600 A	EMP M600 A/A AL
G851 P		EMP M851 P/P AL	G851 X	EMP M851 X/R AL	G851 Y	EMP M851 Y/S AL	G851 A	EMP M851 A/A AL
G1210 P		EMP M1210 P/P AL	G1210 X	EMP M1210 X/R AL	G1210 Y	EMP M1210 Y/S AL	G1210 A	EMP M1210 A/A AL
G1510 P		EMP M1510 P/P AL	G1510 X	EMP M1510 X/R AL	G1510 Y	EMP M1510 Y/S AL	G1510 A	EMP M1510 A/A AL
G1810 P		EMP M1810 P/P AL	G1810 X	EMP M1810 X/R AL	G1810 Y	EMP M1810 Y/S AL	G1810 A	EMP M1810 A/A AL
G2210 P		EMP M2210 P/P AL	G2210 X	EMP M2210 X/R AL	G2210 Y	EMP M2210 Y/S AL	G2210 A	EMP M2210 A/A AL

NOTE: * Valide si une cartouche filtrante "S" est installée en amont.

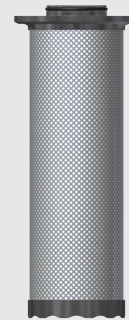

OMI ALps

	QF	PF	HF	CF
OMI Alps Embouts Plastique				
	Retention particules	3 µm	0,1 µm	0,01 µm
Classe de qualité - solides ⁽¹⁾	6	2	1	1*
Classe de qualité - Huile ⁽¹⁾	-	2	1	1
Media Filtrant	fibres acrylique, cellulose		micro fibres de borosilicate	
Température de fct. [°C]	1,5 à 65	1,5 à 65	1,5 à 65	1,5 à 45
DP (élément neuf) [mbar]	10	50	80	60

	QF		PF		HF		CF	
	OMI	EVOAIR	OMI	EVOAIR	OMI	EVOAIR	OMI	EVOAIR
0030AQF	EOM A30 QF/R	0030APF	EOM A30 PF/M	0030AHF	EOM A30 HF/S	0030ACF	EOM A30 CF/A	
0040AQF	EOM A40 QF/R	0040APF	EOM A40 PF/M	0040AHF	EOM A40 HF/S	0040ACF	EOM A40 CF/A	
0075AQF	EOM A75 QF/R	0075APF	EOM A75 PF/M	0075AHF	EOM A75 HF/S	0075ACF	EOM A75 CF/A	
0110AQF	EOM A110 QF/R	0110APF	EOM A110 PF/M	0110AHF	EOM A110 HF/S	0110ACF	EOM A110 CF/A	
0190AQF	EOM A190 QF/R	0190APF	EOM A190 PF/M	0190AHF	EOM A190 HF/S	0190ACF	EOM A190 CF/A	
0260AQF	EOM A260 QF/R	0260APF	EOM A260 PF/M	0260AHF	EOM A260 HF/S	0260ACF	EOM A260 CF/A	
0400AQF	EOM A400 QF/R	0400APF	EOM A400 PF/M	0400AHF	EOM A400 HF/S	0400ACF	EOM F400 CF/A	
0500AQF	EOM A600 QF/R	0500APF	EOM A500 PF/M	0500AHF	EOM A500 HF/S	0500ACF	EOM F500 CF/A	
0800AQF	EOM A800 QF/R	0800APF	EOM A800 PF/M	0800AHF	EOM A800 HF/S	0800ACF	EOM F800 CF/A	
1000AQF	EOM A1000 QF/R	1000APF	EOM A1000 PF/M	1000AHF	EOM A1000 HF/S	1000ACF	EOM F1000 CF/A	
1300AQF	EOM A1300 QF/R	1300APF	EOM A1300 PF/M	1300AHF	EOM A1300 HF/S	1300ACF	EOM F1300 CF/A	
1560AQF	EOM A1560 QF/R	1560APF	EOM A1560 PF/M	1560AHF	EOM A1560 HF/S	1560ACF	EOM F1560 CF/A	
1830AQF	EOM A1830 QF/R	1830APF	EOM A1830 PF/M	1830AHF	EOM A1830 HF/S	1830ACF	EOM F1830 CF/A	
2700AQF	EOM A2700 QF/R	2700APF	EOM A2700 PF/M	2700AHF	EOM A2700 HF/S	2700ACF	EOM F2700 CF/A	

NOTE: * Valide si une cartouche filtrante "S" est installée en amont.

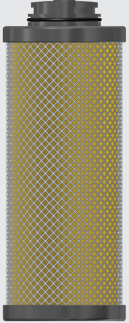

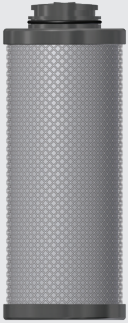

OMI (ancien)

	QF	PF	HF	CF
OMI (ancien) Embouts Plastique				
Retention particules	3 µm	0,1 µm	0,01 µm	charbon actif
Classe de qualité - solides ⁽¹⁾	6	2	1	1*
Classe de qualité - Huile ⁽¹⁾	-	2	1	1
Media Filtrant	fibres acrylique, cellulose	micro fibres de borosilicate		charbon actif
Température de fct. [°C]	1,5 à 65	1,5 à 65	1,5 à 65	1,5 à 45
DP (élément neuf) [mbar]	10	50	80	60

	QF			PF			HF			CF		
	OMI ancien	OMI	EVOAIR	OMI ancien	OMI	EVOAIR	OMI ancien	OMI	EVOAIR	OMI ancien	OMI	EVOAIR
0004 QF	0005 QF	EOM 0004 QF/P	0004 PF	0005 PF	EOM 0004 PF/M	0004 HF	0005 HF	EOM 0004 HF/S	0004 CF	0005 CF	EOM 0004 CF/A	
0008 QF	0010 QF	EOM 0008 QF/P	0008 PF	0010 PF	EOM 0008 PF/M	0008 HF	0010 HF	EOM 0008 HF/S	0008 CF	0010 CF	EOM 0008 CF/A	
0016 QF	0018 QF	EOM 0016 QF/P	0016 PF	0018 PF	EOM 0016 PF/M	0016 HF	0018 HF	EOM 0016 HF/S	0016 CF	0018 CF	EOM 0016 CF/A	
/	0030 QF	EOM 0030 QF/P	/	0030 PF	EOM 0030 PF/M	/	0030 HF	EOM 0030 HF/S	/	0030 CF	EOM 0030 CF/A	
0025 QF	0034 QF	EOM 0025 QF/P	0025 PF	0034 PF	EOM 0025 PF/M	0025 HF	0034 HF	EOM 0025 HF/S	0025 CF	0034 CF	EOM 0025 CF/A	
0036 QF	0050 QF	EOM 0036 QF/P	0036 PF	0050 PF	EOM 0036 PF/M	0036 HF	0050 HF	EOM 0036 HF/S	0036 CF	0050 CF	EOM 0036 CF/A	
/	0072 QF	EOM 0072 QF/P	/	0072 PF	EOM 0072 PF/M	/	0072 HF	EOM 0072 HF/S	/	0072 CF	EOM 0072 CF/A	
0060 QF	0095 QF	EOM 0060 QF/P	0060 PF	0095 PF	EOM 0060 PF/M	0060 HF	0095 HF	EOM 0060 HF/S	0060 CF	0095 CF	EOM 0060 CF/A	
0070 QF	/	EOM 0070 QF/P	0070 PF	/	EOM 0070 PF/M	0070 HF	/	EOM 0070 HF/S	0070 CF	/	EOM 0070 CF/A	
0090 QF	0125 QF	EOM 0090 QF/P	0090 PF	0125 PF	EOM 0090 PF/M	0090 HF	0125 HF	EOM 0090 HF/S	0090 CF	0125 CF	EOM 0090 CF/A	
0120 QF	0165 QF	EOM 0120 QF/P	0120 PF	0165 PF	EOM 0120 PF/M	0120 HF	0165 HF	EOM 0120 HF/S	0120 CF	0165 CF	EOM 0120 CF/A	
/	0190 QF	EOM 0190 QF/P	/	0190 PF	EOM 0190 PF/M	/	0190 HF	EOM 0190 HF/S	/	0190 CF	EOM 0190 CF/A	
0185 QF	0220 QF	EOM 0185 QF/P	0185 PF	0220 PF	EOM 0185 PF/M	0185 HF	0220 HF	EOM 0185 HF/S	0185 CF	0220 CF	EOM 0185 CF/A	
/	0280 QF	EOM 0280 QF/P	/	0280 PF	EOM 0280 PF/M	/	0280 HF	EOM 0280 HF/S	/	0280 CF	EOM 0280 CF/A	
/	0350 QF	EOM 0350 QF/P	/	0350 PF	EOM 0350 PF/M	/	0350 HF	EOM 0350 HF/S	/	0350 CF	EOM 0350 CF/A	
/	0440 QF	EOM 0440 QF/P	/	0440 PF	EOM 0440 PF/M	/	0440 HF	EOM 0440 HF/S	/	0440 CF	EOM 0440 CF/A	

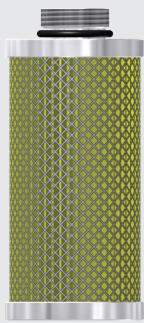
NOTE: * Valide si une cartouche filtrante "S" est installée en amont.





ORION (nouveau)

ORION (nouveau) Embouts Aluminium	DSF	LSF	MSF	KSF
				
Retention particules	3 µm	1 µm	0,01 µm	charbon actif
Classe de qualité - solides ⁽¹⁾	6	3	1	1*
Classe de qualité - Huile ⁽¹⁾	-	-	1	1
Media Filtrant	fibres acrylique, cellulose	micro fibres de borosilicate		charbon actif
Température de fct.[°C]	1,5 à 65	1,5 à 65	1,5 à 65	1,5 à 45
DP (élément neuf) [mbar]	10	20	80	60

	DSF		LSF		MSF		KSF	
	ORION	EVOAIR	ORION	EVOAIR	ORION	EVOAIR	ORION	EVOAIR
	DSF 75	EOR 75 DSF/P AL	LSF 75	EOR 75 LSF/R AL	MSF 75	EOR 75 MSF/S AL	KSF 75	EOR 75 KSF/A AL
DSF 150	EOR 150 DSF/P AL	LSF 150	EOR 150 LSF/R AL	MSF 150	EOR 150 MSF/S AL	KSF 150	EOR 150 KSF/A AL	
DSF 200	EOR 200 DSF/P AL	LSF 200	EOR 200 LSF/R AL	MSF 200	EOR 200 MSF/S AL	KSF 200	EOR 200 KSF/A AL	
DSF 250	EOR 250 DSF/P AL	LSF 250	EOR 250 LSF/R AL	MSF 250	EOR 250 MSF/S AL	KSF 250	EOR 250 KSF/A AL	
DSF 400	EOR 400 DSF/P AL	LSF 400	EOR 400 LSF/R AL	MSF 400	EOR 400 MSF/S AL	KSF 400	EOR 400 KSF/A AL	
DSF 700	EOR 700 DSF/P AL	LSF 700	EOR 700 LSF/R AL	MSF 700	EOR 700 MSF/S AL	KSF 700	EOR 700 KSF/A AL	
DSF 1000	EOR 1000 DSF/P AL	LSF 1000	EOR 1000 LSF/R AL	MSF 1000	EOR 1000 MSF/S AL	KSF 1000	EOR 1000 KSF/A AL	
DSF 1300	EOR 1300 DSF/P AL	LSF 1300	EOR 1300 LSF/R AL	MSF 1300	EOR 1300 MSF/S AL	KSF 1300	EOR 1300 KSF/A AL	
DSF 2000	EOR 2000 DSF/P AL	LSF 2000	EOR 2000 LSF/R AL	MSF 2000	EOR 2000 MSF/S AL	KSF 2000	EOR 2000 KSF/A AL	

NOTE: * Valide si une cartouche filtrante "S" est installée en amont.





PNEUMATECH (nouveau)

	P	G	C	V
PNEUMATECH (nouveau) Embouts Plastique				
	Retention particules	1 µm	0,1 µm	0,01 µm
Classe de qualité - solides ⁽¹⁾	3	2	1	1*
Classe de qualité - Huile ⁽¹⁾	-	2	1	1
Media Filtrant	micro fibres de borosilicate			charbon actif
Température de fct.[°C]	1,5 à 65	1,5 à 65	1,5 à 65	1,5 à 45
DP (élément neuf) [mbar]	20	50	80	60

	P		G		C		V	
	PNEUMATECH	EVOAIR	PNEUMATECH	EVOAIR	PNEUMATECH	EVOAIR	PNEUMATECH	EVOAIR
1 P	EPT 1 P/R		1 G	EPT 1 G/M	1 C	EPT 1 C/S	1 V	EPT 1 V/A
2 P	EPT 2 P/R		2 G	EPT 2 G/M	2 C	EPT 2 C/S	2 V	EPT 2 V/A
3 P	EPT 3 P/R		3 G	EPT 3 G/M	3 C	EPT 3 C/S	3 V	EPT 3 V/A
4 P	EPT 4 P/R		4 G	EPT 4 G/M	4 C	EPT 4 C/S	4 V	EPT 4 V/A
5 P	EPT 5 P/R		5 G	EPT 5 G/M	5 C	EPT 5 C/S	5 V	EPT 5 V/A
6 P	EPT 6 P/R		6 G	EPT 6 G/M	6 C	EPT 6 C/S	6 V	EPT 6 V/A
7 P	EPT 7 P/R		7 G	EPT 7 G/M	7 C	EPT 7 C/S	7 V	EPT 7 V/A
8 P	EPT 8 P/R		8 G	EPT 8 G/M	8 C	EPT 8 C/S	8 V	EPT 8 V/A
9 P	EPT 9 P/R		9 G	EPT 9 G/M	9 C	EPT 9 C/S	9 V	EPT 9 V/A
10 P	EPT 10 P/R		10 G	EPT 10 G/M	10 C	EPT 10 C/S	10 V	EPT 10 V/A
11 P	EPT 11 P/R		11 G	EPT 11 G/M	11 C	EPT 11 C/S	11 V	EPT 11 V/A

NOTE: * Valide si une cartouche filtrante "S" est installée en amont.

PNEUMATECH (ancien)



	MBP	MBM	MBS	MBA
PNEUMATECH (ancien) Embouts Plastique				
	Retention particules	3 µm	0,1 µm	0,01 µm
Classe de qualité - solides ⁽¹⁾	6	2	1	1*
Classe de qualité - Huile ⁽¹⁾	-	2	1	1
Media Filtrant	fibres acrylique, cellulose	micro fibres de borosilicate		charbon actif
Température de fct. [°C]	1,5 à 65	1,5 à 65	1,5 à 65	1,5 à 45
DP (élément neuf) [mbar]	10	50	80	60

	MBP		MBM		MBS		MBA	
	PNEUMATECH	EVOAIR	PNEUMATECH	EVOAIR	PNEUMATECH	EVOAIR	PNEUMATECH	EVOAIR
MBP 35	EPT 35 MBP/P	MBM 35	EPT 35 MBM/M	MBS 35	EPT 35 MBS/S	MBA 35	EPT 35 MBA/A	
MBP 50	EPT 50 MBP/P	MBM 50	EPT 50 MBM/M	MBS 50	EPT 50 MBS/S	MBA 50	EPT 50 MBA/A	
MBP 75	EPT 75 MBP/P	MBM 75	EPT 75 MBM/M	MBS 75	EPT 75 MBS/S	MBA 75	EPT 75 MBA/A	
MBP 120	EPT 120 MBP/P	MBM 120	EPT 120 MBM/M	MBS 120	EPT 120 MBS/S	MBA 120	EPT 120 MBA/A	
MBP 200	EPT 200 MBP/P	MBM 200	EPT 200 MBM/M	MBS 200	EPT 200 MBS/S	MBA 200	EPT 200 MBA/A	
MBP 300	EPT 300 MBP/P	MBM 300	EPT 300 MBM/M	MBS 300	EPT 300 MBS/S	MBA 300	EPT 300 MBA/A	
MBP 460	EPT 460 MBP/P	MBM 460	EPT 460 MBM/M	MBS 460	EPT 460 MBS/S	MBA 460	EPT 460 MBA/A	
MBP 600	EPT 600 MBP/P	MBM 600	EPT 600 MBM/M	MBS 600	EPT 600 MBS/S	MBA 600	EPT 600 MBA/A	
MBP 900	EPT 900 MBP/P	MBM 900	EPT 900 MBM/M	MBS 900	EPT 900 MBS/S	MBA 900	EPT 900 MBA/A	
MBP 1250	EPT 1250 MBP/P	MBM 1250	EPT 1250 MBM/M	MBS 1250	EPT 1250 MBS/S	MBA 1250	EPT 1250 MBA/A	
MBP 1500	EPT 1500 MBP/P	MBM 1500	EPT 1500 MBM/M	MBS 1500	EPT 1500 MBS/S	MBA 1500	EPT 1500 MBA/A	

NOTE: * Valide si une cartouche filtrante "S" est installée en amont.

ELEMENTS FILTRANTS
 ALTERNATIFS



PREVOST MICRO

	M	B	C
PREVOST MICRO Embouts Plastique			
	Retention particules	1 µm	0,01 µm
Classe de qualité - solides ⁽¹⁾	3	1	1*
Classe de qualité - Huile ⁽¹⁾	-	1	1
Media Filtrant	micro fibres de borosilicate		charbon actif
Température de fct. [°C]	1,5 à 65	1,5 à 65	1,5 à 45
DP (élément neuf) [mbar]	20	80	60

	M		B		C	
	PREVOST	EVOAIR	PREVOST	EVOAIR	PREVOST	EVOAIR
101-MFMC	EPR A101 M/R	201-MFBC	EPR A201 B/S	301-MFCC	EPR A301 C/A	
102-MFMC	EPR A102 M/R	202-MFBC	EPR A202 B/S	302-MFCC	EPR A302 C/A	
103-MFMC	EPR A103 M/R	203-MFBC	EPR A203 B/S	303-MFCC	EPR A303 C/A	
104-MFMC	EPR A104 M/R	204-MFBC	EPR A204 B/S	304-MFCC	EPR A304 C/A	
105-MFMC	EPR A105 M/R	205-MFBC	EPR A205 B/S	305-MFCC	EPR A305 C/A	
106-MFMC	EPR A106 M/R	206-MFBC	EPR A206 B/S	306-MFCC	EPR A306 C/A	
107-MFMC	EPR A107 M/R	207-MFBC	EPR A207 B/S	307-MFCC	EPR A307 C/A	
108-MFMC	EPR A108 M/R	208-MFBC	EPR A208 B/S	308-MFCC	EPR A308 C/A	
109-MFMC	EPR A109 M/R	209-MFBC	EPR A209 B/S	309-MFCC	EPR A309 C/A	
110-MFMC	EPR A110 M/R	210-MFBC	EPR A210 B/S	310-MFCC	EPR A310 C/A	
111-MFMC	EPR A111 M/R	211-MFBC	EPR A211 B/S	311-MFCC	EPR A311 C/A	
112-MFMC	EPR A112 M/R	212-MFBC	EPR A212 B/S	312-MFCC	EPR A312 C/A	
113-MFMC	EPR A113 M/R	213-MFBC	EPR A213 B/S	313-MFCC	EPR A313 C/A	
114-MFMC	EPR A114 M/R	214-MFBC	EPR A214 B/S	314-MFCC	EPR A314 C/A	





NOTE: * Valide si une cartouche filtrante "S" est installée en amont.

PREVOST

	M	S	C
PREVOST Embouts Aluminium			
	Retention particules 1 µm	Retention particules 0,01 µm	Retention particules charbon actif
Classe de qualité - solides ⁽¹⁾	3	1	1*
Classe de qualité - Huile ⁽¹⁾	-	1	1
Media Filtrant	micro fibres de borosilicate		charbon actif
Température de fct. [°C]	1,5 à 65	1,5 à 65	1,5 à 45
DP (élément neuf) [mbar]	20	80	60

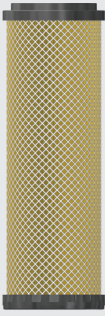
	M		S		C	
	PREVOST	EVOAIR	PREVOST	EVOAIR	PREVOST	EVOAIR
MCAM 101	EPR 101 M/R AL	MCAM 201	EPR 201 S/S AL	MCAM 301	EPR 301 C/A AL	
MCAM 102	EPR 102 M/R AL	MCAM 202	EPR 202 S/S AL	MCAM 302	EPR 302 C/A AL	
MCAM 103	EPR 103 M/R AL	MCAM 203	EPR 203 S/S AL	MCAM 303	EPR 303 C/A AL	
MCAM 104	EPR 104 M/R AL	MCAM 204	EPR 204 S/S AL	MCAM 304	EPR 304 C/A AL	
MCAM 105	EPR 105 M/R AL	MCAM 205	EPR 205 S/S AL	MCAM 305	EPR 305 C/A AL	
MCAM 106	EPR 106 M/R AL	MCAM 206	EPR 206 S/S AL	MCAM 306	EPR 306 C/A AL	
MCAM 107	EPR 107 M/R AL	MCAM 207	EPR 207 S/S AL	MCAM 307	EPR 307 C/A AL	
MCAM 108	EPR 108 M/R AL	MCAM 208	EPR 208 S/S AL	MCAM 308	EPR 308 C/A AL	
MCAM 109	EPR 109 M/R AL	MCAM 209	EPR 209 S/S AL	MCAM 309	EPR 309 C/A AL	
MCAM 110	EPR 110 M/R AL	MCAM 210	EPR 210 S/S AL	MCAM 310	EPR 310 C/A AL	
MCAM 111	EPR 111 M/R AL	MCAM 211	EPR 211 S/S AL	MCAM 311	EPR 311 C/A AL	



NOTE: * Valide si une cartouche filtrante "S" est installée en amont.

	MBP	MBM	MBS	MBA
PUSKA Embouts Plastique				
Retention particules	3 µm	0,1 µm	0,01 µm	charbon actif
Classe de qualité - solides ⁽¹⁾	6	2	1	1*
Classe de qualité - Huile ⁽¹⁾	-	2	1	1
Media Filtrant	fibres acrylique, cellulose	micro fibres de borosilicate		charbon actif
Température de fct. [°C]	1,5 à 65	1,5 à 65	1,5 à 65	1,5 à 45
DP (élément neuf) [mbar]	10	50	80	60

	MBP		MBM		MBS		MBA	
	PUSKA	EVOAIR	PUSKA	EVOAIR	PUSKA	EVOAIR	PUSKA	EVOAIR
MBP 10		EPU 10 MBP/P	MBM 10	EPU 10 MBM/M	MBS 10	EPU 10 MBS/S	MBA 10	EPU 10 MBA/A
MBP 13		EPU 13 MBP/P	MBM 13	EPU 13 MBM/M	MBS 13	EPU 13 MBS/S	MBA 13	EPU 13 MBA/A
MBP 20		EPU 20 MBP/P	MBM 20	EPU 20 MBM/M	MBS 20	EPU 20 MBS/S	MBA 20	EPU 20 MBA/A
MBP 33		EPU 33 MBP/P	MBM 33	EPU 33 MBM/M	MBS 33	EPU 33 MBS/S	MBA 33	EPU 33 MBA/A
MBP 60		EPU 60 MBP/P	MBM 60	EPU 60 MBM/M	MBS 60	EPU 60 MBS/S	MBA 60	EPU 60 MBA/A
MBP 85		EPU 85 MBP/P	MBM 85	EPU 85 MBM/M	MBS 85	EPU 85 MBS/S	MBA 85	EPU 85 MBA/A
MBP 130		EPU 130 MBP/P	MBM 130	EPU 130 MBM/M	MBS 130	EPU 130 MBS/S	MBA 130	EPU 130 MBA/A
MBP 170		EPU 170 MBP/P	MBM 170	EPU 170 MBM/M	MBS 170	EPU 170 MBS/S	MBA 170	EPU 170 MBA/A
MBP 250		EPU 250 MBP/P	MBM 250	EPU 250 MBM/M	MBS 250	EPU 250 MBS/S	MBA 250	EPU 250 MBA/A
MBP 400		EPU 400 MBP/P	MBM 400	EPU 400 MBM/M	MBS 400	EPU 400 MBS/S	MBA 400	EPU 400 MBA/A

NOTE: * Valide si une cartouche filtrante "S" est installée en amont.

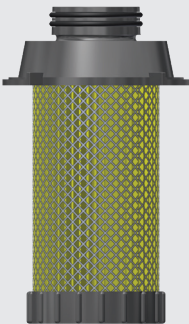
SCHNEIDER

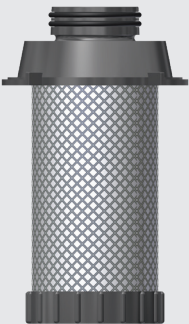



	VP	FP	AP
SCHNEIDER Embouts Plastique			
	Retention particules	3 µm	0,01 µm
Classe de qualité - solides ⁽¹⁾	6	1	1*
Classe de qualité - Huile ⁽¹⁾	-	1	1
Media Filtrant	fibres acrylique, cellulose		charbon actif
Température de fct.[°C]	1,5 à 65	1,5 à 65	1,5 à 45
DP (élément neuf) [mbar]	10	80	60

	VP		FP		AP	
	SCHNEIDER	EVOAIR	SCHNEIDER	EVOAIR	SCHNEIDER	EVOAIR
	F-VP 6	ESC 6 VP/P	F-FP 6	ESC 6 FP/S	F-AP 6	ESC 6 AP/A
	F-VP 10	ESC 10 VP/P	F-FP 10	ESC 10 FP/S	F-AP 10	ESC 10 AP/A
	F-VP 15	ESC 15 VP/P	F-FP 15	ESC 15 FP/S	F-AP 15	ESC 15 AP/A
	F-VP 30	ESC 30 VP/P	F-FP 30	ESC 30 FP/S	F-AP 30	ESC 30 AP/A
	F-VP 45	ESC 45 VP/P	F-FP 45	ESC 45 FP/S	F-AP 45	ESC 45 AP/A
	F-VP 80	ESC 80 VP/P	F-FP 80	ESC 80 FP/S	F-AP 80	ESC 80 AP/A
	F-VP 160	ESC 160 VP/P	F-FP 160	ESC 160 FP/S	F-AP 160	ESC 160 AP/A

NOTE: * Valide si une cartouche filtrante "S" est installée en amont.

ELEMENTS FILTRANTS ALTERNATIFS





SMC

SMC Embouts Aluminium	AFF	AM	AMD	AMF
				
Retention particules	3 µm	0,1 µm	0,01 µm	charbon actif
Classe de qualité - solides ⁽¹⁾	6	2	1	1*
Classe de qualité - Huile ⁽¹⁾	-	2	1	1
Media Filtrant	fibres acrylique, cellulose		micro fibres de borosilicate	
Température de fct.[°C]	1,5 à 65	1,5 à 65	1,5 à 65	1,5 à 45
DP (élément neuf) [mbar]	10	50	80	60

SMC	AFF		AM		AMD		AMF	
	SMC	EVOAIR	SMC	EVOAIR	SMC	EVOAIR	SMC	EVOAIR
AFF-EL2B	ESMC 150 AFF/P AL	AM-EL150	ESMC 150 AM/M AL	AMD-EL150	ESMC 150 AMD/S AL	AMF-EL150	ESMC 150 AMF/A AL	
AFF-EL4B	ESMC 250 AFF/P AL	AM-EL250	ESMC 250 AM/M AL	AMD-EL250	ESMC 250 AMD/S AL	AMF-EL250	ESMC 250 AMF/A AL	
AFF-EL8B	ESMC 350 AFF/P AL	AM-EL350	ESMC 350 AM/M AL	AMD-EL350	ESMC 350 AMD/S AL	AMF-EL350	ESMC 350 AMF/A AL	
AFF-EL11B	ESMC 450 AFF/P AL	AM-EL450	ESMC 450 AM/M AL	AMD-EL450	ESMC 450 AMD/S AL	AMF-EL450	ESMC 450 AMF/A AL	
AFF-EL22B	ESMC 550 AFF/P AL	AM-EL550	ESMC 550 AM/M AL	AMD-EL550	ESMC 550 AMD/S AL	AMF-EL550	ESMC 550 AMF/A AL	
AFF-EL37B	ESMC 650 AFF/P AL	AM-EL650	ESMC 650 AM/M AL	AMD-EL650	ESMC 650 AMD/S AL	AMF-EL650	ESMC 650 AMF/A AL	
AFF-EL75B	ESMC 850 AFF/P AL	AM-EL850	ESMC 850 AM/M AL	AMD-EL850	ESMC 850 AMD/S AL	AMF-EL850	ESMC 850 AMF/A AL	

NOTE: * Valide si une cartouche filtrante "S" est installée en amont.



**ELEMENTS FILTRANTS
 ALTERNATIFS**
SPX NGF

SPX NGF Embouts Plastique	SF	PF	HF	CF
				
Retention particules	3 µm	1 µm	0,01 µm	charbon actif
Classe de qualité - solides ⁽¹⁾	6	3	1	1*
Classe de qualité - Huile ⁽¹⁾	-	-	1	1
Media Filtrant	fibres acrylique, cellulose	micro fibres de borosilicate		charbon actif
Température de fct.[°C]	1,5 à 65	1,5 à 65	1,5 à 65	1,5 à 45
DP (élément neuf) [mbar]	10	20	80	60

SPX	SF		PF		HF		CF	
	SPX	EVOAIR	SPX	EVOAIR	SPX	EVOAIR	SPX	EVOAIR
02-SF	ESP 02 SF/P	02-PF	ESP 02 PF/R	02-HF	ESP 02 HF/S	02-CF	ESP 02 CF/A	
03-SF	ESP 03 SF/P	03-PF	ESP 03 PF/R	03-HF	ESP 03 HF/S	03-CF	ESP 03 CF/A	
04-SF	ESP 04 SF/P	04-PF	ESP 04 PF/R	04-HF	ESP 04 HF/S	04-CF	ESP 04 CF/A	
06-SF	ESP 06 SF/P	06-PF	ESP 06 PF/R	06-HF	ESP 06 HF/S	06-CF	ESP 06 CF/A	
07-SF	ESP 07 SF/P	07-PF	ESP 07 PF/R	07-HF	ESP 07 HF/S	07-CF	ESP 07 CF/A	
08-SF	ESP 08 SF/P	08-PF	ESP 08 PF/R	08-HF	ESP 08 HF/S	08-CF	ESP 08 CF/A	
10-SF	ESP 10 SF/P	10-PF	ESP 10 PF/R	10-HF	ESP 10 HF/S	10-CF	ESP 10 CF/A	
11-SF	ESP 11 SF/P	11-PF	ESP 11 PF/R	11-HF	ESP 11 HF/S	11-CF	ESP 11 CF/A	
12-SF	ESP 12 SF/P	12-PF	ESP 12 PF/R	12-HF	ESP 12 HF/S	12-CF	ESP 12 CF/A	
13-SF	ESP 13 SF/P	13-PF	ESP 13 PF/R	13-HF	ESP 13 HF/S	13-CF	ESP 13 CF/A	
14-SF	ESP 14 SF/P	14-PF	ESP 14 PF/R	14-HF	ESP 14 HF/S	14-CF	ESP 14 CF/A	
15-SF	ESP 15 SF/P	15-PF	ESP 15 PF/R	15-HF	ESP 15 HF/S	15-CF	ESP 15 CF/A	
16-SF	ESP 16 SF/P	16-PF	ESP 16 PF/R	16-HF	ESP 16 HF/S	16-CF	ESP 16 CF/A	
17-SF	ESP 17 SF/P	17-PF	ESP 17 PF/R	17-HF	ESP 17 HF/S	17-CF	ESP 17 CF/A	

ELEMENTS FILTRANTS
 ALTERNATIFS





SULLAIR

	SCF	SCH	SCC
SULLAIR Embouts Plastique			
Retention particules	1 µm	0,01 µm	charbon actif
Classe de qualité - solides ⁽¹⁾	3	1	1*
Classe de qualité - Huile ⁽¹⁾	-	1	1
Media Filtrant	micro fibres de borosilicate		charbon actif
Température de fct.[°C]	1,5 à 65	1,5 à 65	1,5 à 45
DP (élément neuf) [mbar]	20	80	60

	SCF		SCH		SCC	
	SULLAIR	EVOAIR	SULLAIR	EVOAIR	SULLAIR	EVOAIR
20 SCF	20 SCF/R	20 SCF/R	20 SCH	20 SCH/S	20 SCC	20 SCC/A
40 SCF	40 SCF/R	40 SCF/R	40 SCH	40 SCH/S	40 SCC	40 SCC/A
65 SCF	65 SCF/R	65 SCF/R	65 SCH	65 SCH/S	65 SCC	65 SCC/A
125 SCF	125 SCF/R	125 SCF/R	125 SCH	125 SCH/S	125 SCC	125 SCC/A
235 SCF	235 SCF/R	235 SCF/R	235 SCH	235 SCH/S	235 SCC	235 SCC/A
340 SCF	340 SCF/R	340 SCF/R	340 SCH	340 SCH/S	340 SCC	340 SCC/A
465 SCF	465 SCF/R	465 SCF/R	465 SCH	465 SCH/S	465 SCC	465 SCC/A
700 SCF	700 SCF/R	700 SCF/R	700 SCH	700 SCH/S	700 SCC	700 SCC/A
910 SCF	910 SCF/R	910 SCF/R	910 SCH	910 SCH/S	910 SCC	910 SCC/A
1315 SCF	1315 SCF/R	1315 SCF/R	1315 SCH	1315 SCH/S	1315 SCC	1315 SCC/A
2120 SCF	2120 SCF/R	2120 SCF/R	2120 SCH	2120 SCH/S	2120 SCC	2120 SCC/A

NOTE: * Valide si une cartouche filtrante "S" est installée en amont.

WALKER OWA ALfa





WALKER OWA Alfa Embouts Plastique	X5	X1	XA	AC
				
Retention particules	3 µm	0,1 µm	0,01 µm	charbon actif
Classe de qualité - solides ⁽¹⁾	6	2	1	1*
Classe de qualité - Huile ⁽¹⁾	-	2	1	1
Media Filtrant	fibres acrylique, cellulose	micro fibres de borosilicate		charbon actif
Température de fct.[°C]	1,5 à 65	1,5 à 65	1,5 à 65	1,5 à 45
DP (élément neuf) [mbar]	10	50	80	60

WALKER	X5		X1		XA		AC	
	WALKER	EVOAIR	WALKER	EVOAIR	WALKER	EVOAIR	WALKER	EVOAIR
E0304 X5	EWA AE0304 X5/P	E0304 X1	EWA AE0304 X1/M	E0304 XA	EWA AE0304 XA/S	E0304 AC	EWA AE0304 AC/A	
E0305 X5	EWA AE0305 X5/P	E0305 X1	EWA AE0305 X1/M	E0305 XA	EWA AE0305 XA/S	E0305 AC	EWA AE0305 AC/A	
E0406 X5	EWA AE0406 X5/P	E0406 X1	EWA AE0406 X1/M	E0406 XA	EWA AE0406 XA/S	E0406 AC	EWA AE0406 AC/A	
E0407 X5	EWA AE0407 X5/P	E0407 X1	EWA AE0407 X1/M	E0407 XA	EWA AE0407 XA/S	E0407 AC	EWA AE0407 AC/A	
E0413 X5	EWA AE0413 X5/P	E0413 X1	EWA AE0413 X1/M	E0413 XA	EWA AE0413 XA/S	E0413 AC	EWA AE0413 AC/A	
E0613 X5	EWA AE0613 X5/P	E0613 X1	EWA AE0613 X1/M	E0613 XA	EWA AE0613 XA/S	E0613 AC	EWA AE 0613 AC/A	
E0620 X5	EWA AE0620 X5/P	E0620 X1	EWA AE0620 X1/M	E0620 XA	EWA AE0620 XA/S	E0620 AC	EWA AE 0620 AC/A	
E0625 X5	EWA AE0625 X5/P	E0625 X1	EWA AE0625 X1/M	E0625 XA	EWA AE0625 XA/S	E0625 AC	EWA AE 0625 AC/A	
E0730 X5	EWA AE0730 X5/P	E0730 X1	EWA AE0730 X1/M	E0730 XA	EWA AE0730 XA/S	E0730 AC	EWA AE 0730 AC/A	
E0830 X5	EWA AE0830 X5/P	E0830 X1	EWA AE0830 X1/M	E0830 XA	EWA AE0830 XA/S	E0830 AC	EWA AE 0830 AC/A	
E0860 X5	EWA AE0860 X5/P	E0860 X1	EWA AE0860 X1/M	E0860 XA	EWA AE0860 XA/S	E0860 AC	EWA AE 0860 AC/A	
E1140 X5	EWA AE1140 X5/P	E1140 X1	EWA AE1140 X1/M	E1140 XA	EWA AE1140 XA/S	E1140 AC	EWA AE 1140 AC/A	
E1160 X5	EWA AE1160 X5/P	E1160 X1	EWA AE1160 X1/M	E1160 XA	EWA AE1160 XA/S	E1160 AC	EWA AE 1160 AC/A	
E1175 X5	EWA AE1175 X5/P	E1175 X1	EWA AE1175 X1/M	E1175 XA	EWA AE1175 XA/S	E1175 AC	EWA AE 1175 AC/A	

NOTE: * Valide si une cartouche filtrante "S" est installée en amont.

ELEMENTS FILTRANTS
 ALTERNATIFS





WALKER

	X5	X1	XA	AC	MV
WALKER Embouts Aluminium					
Retention particules	3 µm	0,1 µm	0,01 µm	charbon actif	Vide medical
Classe de qualité - solides ⁽¹⁾	6	2	1	1*	-
Classe de qualité - Huile ⁽¹⁾	-	2	1	1	-
Media Filtrant	fibres acrylique, cellulose	micro fibres de borosilicate		charbon actif	-
Température de fct.[°C]	1,5 à 65	1,5 à 65	1,5 à 65	1,5 à 45	1,5 à 65
DP (élément neuf) [mbar]	10	50	80	60	-

	X5		X1		XA		AC		MV	
	WALKER	EVOAIR	WALKER	EVOAIR	WALKER	EVOAIR	WALKER	EVOAIR	WALKER	EVOAIR
E361-X5	EWA E361 X5/P AL		E361-X1	EWA E361 X1/M AL	E361-XA	EWA E361 XA/S AL	E361-AC	EWA E361 AC/A AL	E511 MV	EWA E511 MV/M-VAC AL
E371-X5	EWA E371 X5/P AL		E371-X1	EWA E371 X1/M AL	E371-XA	EWA E371 XA/S AL	E381-AC	EWA E381 AC/A AL	E521 MV	EWA E521 MV/M-VAC AL
-	-		-	-	-	-	E371-AC	EWA E371 AC/A AL	E811 MV	EWA E811 MV/M-VAC AL
E511-X5	EWA E511 X5/P AL		E511-X1	EWA E511 X1/M AL	E511-XA	EWA E511 XA/S AL	E511-AC	EWA E511 AC/A AL	E821 MV	EWA E821 MV/M-VAC AL
E711-X5	EWA E711 X5/P AL		E711-X1	EWA E711 X1/M AL	E711-XA	EWA E711 XA/S AL	E711-AC	EWA E711 AC/A AL	E831 MV	EWA E831 MV/M-VAC AL
E811-X5	EWA E811 X5/P AL		E811-X1	EWA E811 X1/M AL	E811-XA	EWA E811 XA/S AL	E811-AC	EWA E811 AC/A AL	E851 MV	EWA E851 MV/M-VAC AL
E731-X5	EWA E731 X5/P AL		E731-X1	EWA E731 X1/M AL	E731-XA	EWA E731 XA/S AL	E731-AC	EWA E731 AC/A AL	E1261 MV	EWA E1261 MV/M-VAC AL
E821-X5	EWA E821 X5/P AL		E821-X1	EWA E821 X1/M AL	E821-XA	EWA E821 XA/S AL	E821-AC	EWA E821 AC/A AL	E1281 MV	EWA E1281 MV/M-VAC AL
E831-X5	EWA E831 X5/P AL		E831-X1	EWA E831 X1/M AL	E831-XA	EWA E831 XA/S AL	E831-AC	EWA E831 AC/A AL	E139 MV	EWA E139 MV/M-VAC AL
E851-X5	EWA E851 X5/P AL		E851-X1	EWA E851 X1/M AL	E851-XA	EWA E851 XA/S AL	E851-AC	EWA E851 AC/A AL	E88 MV	EWA E88 MV/M-VAC AL
E1251-X5	EWA E1251 X5/P AL		E1251-X1	EWA E1251 X1/M AL	E1251-XA	EWA E1251 XA/S AL	E1251-AC	EWA E1251 AC/A AL		
E1261-X5	EWA E1261 X5/P AL		E1261-X1	EWA E1261 X1/M AL	E1261-XA	EWA E1261 XA/S AL	E1261-AC	EWA E1261 AC/A AL		
E1281-X5	EWA E1281 X5/P AL		E1281-X1	EWA E1281 X1/M AL	E1281-XA	EWA E1281 XA/S AL	E1281-AC	EWA E1281 AC/A AL		

NOTE: * Valide si une cartouche filtrante "S" est installée en amont.





WALKER HP

WALKER HP Embouts Aluminium	X5	X1	XA	AC
				
Retention particules	3 µm	0,1 µm	0,01 µm	charbon actif
Classe de qualité - solides ⁽¹⁾	6	2	1	1*
Classe de qualité - Huile ⁽¹⁾	-	2	1	1
Media Filtrant	fibres acrylique, cellulose	micro fibres de borosilicate		charbon actif
Température de fct.[°C]	1,5 à 65	1,5 à 65	1,5 à 65	1,5 à 45
DP (élément neuf) [mbar]	10	50	80	60

	X5		X1		XA		AC	
	WALKER	EVOAIR	WALKER	EVOAIR	WALKER	EVOAIR	WALKER	EVOAIR
E50-X5	EWA E50 X5/P AL	E50-X1	EWA E50 X1/M AL	E50-XA	EWA E50 XA/S AL	E50-AC	EWA E50 AC/A AL	
E51-X5	EWA E51 X5/P AL	E51-X1	EWA E51 X1/M AL	E51-XA	EWA E51 XA/S AL	E51-AC	EWA E51 AC/A AL	
E52-X5	EWA E52 X5/P AL	E52-X1	EWA E52 X1/M AL	E52-XA	EWA E52 XA/S AL	E52-AC	EWA E52 AC/A AL	
E715-X5	EWA E715 X5/P AL	E715-X1	EWA E715 X1/M AL	E715-XA	EWA E715 XA/S AL	E715-AC	EWA E715 AC/A AL	
E730-X5	EWA E730 X5/P AL	E730-X1	EWA E730 X1/M AL	E730-XA	EWA E730 XA/S AL	E730-AC	EWA E730 AC/A AL	
E830-X5	EWA E830 X5/P AL	E830-X1	EWA E830 X1/M AL	E830-XA	EWA E830 XA/S AL	E830-AC	EWA E830 AC/A AL	
E86-X5	EWA E86 X5/P AL	E86-X1	EWA E86 X1/M AL	E86-XA	EWA E86 XA/S AL	E86-AC	EWA E86 AC/A AL	

NOTE: * Valide si une cartouche filtrante "S" est installée en amont.





WORTHINGÀN CREYSSENSAC (nouveau)

	P	G	C	V
WORTHINGTON CREYSSENSAC (nouveau) Embouts Plastique				
Retention particules	1 µm	0,1 µm	0,01 µm	charbon actif
Classe de qualité - solides ⁽¹⁾	3	2	1	1*
Classe de qualité - Huile ⁽¹⁾	-	2	1	1
Media Filtrant	micro fibres de borosilicate			charbon actif
Température de fct. [°C]	1,5 à 65	1,5 à 65	1,5 à 65	1,5 à 45
DP (élément neuf) [mbar]	20	50	80	60

	P		G		C		V	
	WORTHINGÀN CREYSSENSAC	EVOAIR	WORTHINGÀN CREYSSENSAC	EVOAIR	WORTHINGÀN CREYSSENSAC	EVOAIR	WORTHINGÀN CREYSSENSAC	EVOAIR
FILTER 45	EWC 45 P/R		FILTER 45	EWC 45 G/M	FILTER 45	EWC 45 C/S	FILTER 45	EWC 45 V/A
FILTER 90	EWC 90 P/R		FILTER 90	EWC 90 G/M	FILTER 90	EWC 90 C/S	FILTER 90	EWC 90 V/A
FILTER 125	EWC 125 P/R		FILTER 125	EWC 125 G/M	FILTER 125	EWC 125 C/S	FILTER 125	EWC 125 V/A
FILTER 180	EWC 180 P/R		FILTER 180	EWC 180 G/M	FILTER 180	EWC 180 C/S	FILTER 180	EWC 180 V/A
FILTER 290	EWC 290 P/R		FILTER 290	EWC 290 G/M	FILTER 290	EWC 290 C/S	FILTER 290	EWC 290 V/A
FILTER 505	EWC 505 P/R		FILTER 505	EWC 505 G/M	FILTER 505	EWC 505 C/S	FILTER 505	EWC 505 V/A
FILTER 685	EWC 685 P/R		FILTER 685	EWC 685 G/M	FILTER 685	EWC 685 C/S	FILTER 685	EWC 685 V/A
FILTER 935	EWC 935 P/R		FILTER 935	EWC 935 G/M	FILTER 935	EWC 935 C/S	FILTER 935	EWC 935 V/A
FILTER 1295	EWC 1295 P/R		FILTER 1295	EWC 1295 G/M	FILTER 1295	EWC 1295 C/S	FILTER 1295	EWC 1295 V/A
FILTER 1890	EWC 1890 P/R		FILTER 1890	EWC 1890 G/M	FILTER 1890	EWC 1890 C/S	FILTER 1890	EWC 1890 V/A
FILTER 2430	EWC 2430 P/R		FILTER 2430	EWC 2430 G/M	FILTER 2430	EWC 2430 C/S	FILTER 2430	EWC 2430 V/A

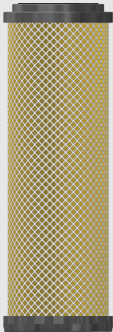
NOTE: * Valide si une cartouche filtrante "S" est installée en amont.

WORTHINGÀN CREYSSENSAC (ancien)



	MBP	MBM	MBS	MBA
WORTHINGTON CREYSSENSAC (ancien)				
Embouts Plastique				
Retention particules	3 µm	0,1 µm	0,01 µm	charbon actif
Classe de qualité - solides ⁽¹⁾	6	2	1	1*
Classe de qualité - Huile ⁽¹⁾	-	2	1	1
Media Filtrant	fibres acrylique, cellulose	micro fibres de borosilicate		charbon actif
Température de fct. [°C]	1,5 à 65	1,5 à 65	1,5 à 65	1,5 à 45
DP (élément neuf) [mbar]	10	50	80	60

	MBP		MBM		MBS		MBA	
	WORTHINGÀN CREYSSENSAC	EVOAIR	WORTHINGÀN CREYSSENSAC	EVOAIR	WORTHINGÀN CREYSSENSAC	EVOAIR	WORTHINGÀN CREYSSENSAC	EVOAIR
MBP 60	EWC 60 MBP/P		MBM 60	EWC 60 MBM/M	MBS 60	EWC 60 MBAS/S	MBA 60	EWC 60 MBA/A
MBP 80	EWC 80 MBP/P		MBM 80	EWC 80 MBM/M	MBS 80	EWC 80 MBAS/S	MBA 80	EWC 80 MBA/A
MBP 120	EWC 120 MBP/P		MBM 120	EWC 120 MBM/M	MBS 120	EWC 120 MBS/S	MBA 120	EWC 120 MBA/A
MBP 200	EWC 200 MBP/P		MBM 200	EWC 200 MBM/M	MBS 200	EWC 200 MBS/S	MBA 200	EWC 200 MBA/A
MBP 340	EWC 340 MBP/P		MBM 340	EWC 340 MBM/M	MBS 340	EWC 340 MBS/S	MBA 340	EWC 340 MBA/A
MBP 510	EWC 510 MBP/P		MBM 510	EWC 510 MBM/M	MBS 510	EWC 510 MBS/S	MBA 510	EWC 510 MBA/A
MBP 800	EWC 800 MBP/P		MBM 800	EWC 800 MBM/M	MBS 800	EWC 800 MBS/S	MBA 800	EWC 800 MBA/A
MBP 1000	EWC 1000 MBP/P		MBM 1000	EWC 1000 MBM/M	MBS 1000	EWC 1000 MBS/S	MBA 1000	EWC 1000 MBA/A
MBP 1500	EWC 1500 MBP/P		MBM 1500	EWC 1500 MBM/M	MBS 1500	EWC 1500 MBS/S	MBA 1500	EWC 1500 MBA/A
MBP 2400	EWC 2400 MBP/P		MBM 2400	EWC 2400 MBM/M	MBS 2400	EWC 2400 MBS/S	MBA 2400	EWC 2400 MBA/A

NOTE: * Valide si une cartouche filtrante "S" est installée en amont.

evoair ELEMENTS FILTRANTS
AIR COMPRIMÉ ALTERNATIFS

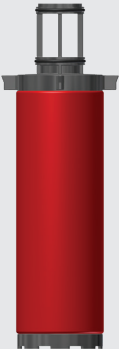



ZANDER GL

	VL	ZL	XL	A
ZANDER GL Embouts Plastique				
	Retention particules	3 µm	1 µm	0,01 µm
Classe de qualité - solides ⁽¹⁾	6	3	1	1*
Classe de qualité - Huile ⁽¹⁾	-	-	1	1
Media Filtrant	fibres acrylique, cellulose	micro fibres de borosilicate		charbon actif
Température de fct. [°C]	1,5 à 65	1,5 à 65	1,5 à 65	1,5 à 45
DP (élément neuf) [mbar]	10	20	80	60

	VL		ZL		XL		A	
	ZANDER	EVOAIR	ZANDER	EVOAIR	ZANDER	EVOAIR	ZANDER	EVOAIR
CP1008VL	EZA GL 1008 VL/P	CP1008ZL	EZA GL 1008 ZL/R	CP1008XL	EZA GL 1008 XL/S	CP1008A	EZA GL 1008 A/A	
CP2010VL	EZA GL 2010 VL/P	CP2010ZL	EZA GL 2010 ZL/R	CP2010XL	EZA GL 2010 XL/S	CP2010A	EZA GL 2010 A/A	
CP2020VL	EZA GL 2020 VL/P	CP2020ZL	EZA GL 2020 ZL/R	CP2020XL	EZA GL 2020 XL/S	CP2020A	EZA GL 2020 A/A	
CP3025VL	EZA GL 3025 VL/P	CP3025ZL	EZA GL 3025 ZL/R	CP3025XL	EZA GL 3025 XL/S	CP3025A	EZA GL 3025 A/A	
CP3040VL	EZA GL 3040 VL/P	CP3040ZL	EZA GL 3040 ZL/R	CP3040XL	EZA GL 3040 XL/S	CP3040A	EZA GL 3040 A/A	
CP4040VL	EZA GL 4040 VL/P	CP4040ZL	EZA GL 4040 ZL/R	CP4040XL	EZA GL 4040 XL/S	CP4040A	EZA GL 4040 A/A	
CP4050VL	EZA GL 4050 VL/P	CP4050ZL	EZA GL 4050 ZL/R	CP4050XL	EZA GL 4050 XL/S	CP4050A	EZA GL 4050 A/A	
CP4065VL	EZA GL 4065 VL/P	CP4065ZL	EZA GL 4065 ZL/R	CP4065XL	EZA GL 4065 XL/S	CP4065A	EZA GL 4065 A/A	
CP5065VL	EZA GL 5065 VL/P	CP5065ZL	EZA GL 5065 ZL/R	CP5065XL	EZA GL 5065 XL/S	CP5065A	EZA GL 5065 A/A	
CP5080VL	EZA GL 5080 VL/P	CP5080ZL	EZA GL 5080 ZL/R	CP5080XL	EZA GL 5080 XL/S	CP5080A	EZA GL 5080 A/A	

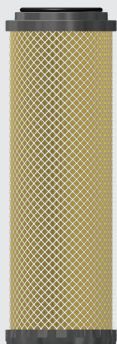
NOTE: * Valide si une cartouche filtrante "S" est installée en amont.

ZANDER





ZANDER Embouts Plastique	V	Z (ZP)	Y	X (XP)	A
					
Retention particules	3 µm	1 µm	0,1 µm	0,01 µm	charbon actif
Classe de qualité - solides ⁽¹⁾	6	3	2	1	1*
Classe de qualité - Huile ⁽¹⁾	-	-	2	1	1
Media Filtrant	fibres acrylique, cellulose		micro fibres de borosilicate		charbon actif
Température de fct.[°C]	1,5 à 65	1,5 à 65	1,5 à 65	1,5 à 65	1,5 à 45
DP (élément neuf) [mbar]	10	20	50	80	60

	V		Z (ZP)		Y		X (XP)		A	
	ZANDER	EVOAIR	ZANDER	EVOAIR	ZANDER	EVOAIR	ZANDER	EVOAIR	ZANDER	EVOAIR
1030 V	EZA 1030 V/P	1030 Z	EZA 1030 Z/R	1030 Y	EZA 1030 Y/M	1030 X	EZA 1030 X/S	1030 A	EZA 1030 A/A	
1050 V	EZA 1050 V/P	1050 Z	EZA 1050 Z/R	1050 Y	EZA 1050 Y/M	1050 X	EZA 1050 X/S	1050 A	EZA 1050 A/A	
1070 V	EZA 1070 V/P	1070 Z	EZA 1070 Z/R	1070 Y	EZA 1070 Y/M	1070 X	EZA 1070 X/S	1070 A	EZA 1070 A/A	
1140 V	EZA 1140 V/P	1140 Z	EZA 1140 Z/R	1140 Y	EZA 1140 Y/M	1140 X	EZA 1140 X/S	1140 A	EZA 1140 A/A	
2010 V	EZA 2010 V/P	2010 Z	EZA 2010 Z/R	2010 Y	EZA 2010 Y/M	2010 X	EZA 2010 X/S	2010 A	EZA 2010 A/A	
2020 V	EZA 2020 V/P	2020 Z	EZA 2020 Z/R	2020 Y	EZA 2020 Y/M	2020 X	EZA 2020 X/S	2020 A	EZA 2020 A/A	
2030 V	EZA 2030 V/P	2030 Z	EZA 2030 Z/R	2030 Y	EZA 2030 Y/M	2030 X	EZA 2030 X/S	2030 A	EZA 2030 A/A	
2050 V	EZA 2050 V/P	2050 Z	EZA 2050 Z/R	2050 Y	EZA 2050 Y/M	2050 X	EZA 2050 X/S	2050 A	EZA 2050 A/A	
3050 V	EZA 3050 V/P	3050 Z	EZA 3050 Z/R	3050 Y	EZA 3050 Y/M	3050 X	EZA 3050 X/S	3050 A	EZA 3050 A/A	
3075 V	EZA 3075 V/P	3075 Z	EZA 3075 Z/R	3075 Y	EZA 3075 Y/M	3075 X	EZA 3075 X/S	3075 A	EZA 3075 A/A	
5060 V	EZA 5060 V/P	5060 Z	EZA 5060 Z/R	5060 Y	EZA 5060 Y/M	5060 X	EZA 5060 X/S	5060 A	EZA 5060 A/A	
5075 V	EZA 5075 V/P	5075 Z	EZA 5075 Z/R	5075 Y	EZA 5075 Y/M	5075 X	EZA 5075 X/S	5075 A	EZA 5075 A/A	

NOTE: * Valide si une cartouche filtrante "S" est installée en amont.

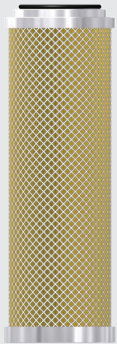
evoair ELEMENTS FILTRANTS
AIR COMPRIMÉ ALTERNATIFS

ZANDER



	V	Z (ZP)	Y	X (XP)	A
ZANDER Embouts Aluminium					
Retention particules	3 µm	1 µm	0,1 µm	0,01 µm	charbon actif
Classe de qualité - solides ⁽¹⁾	6	3	2	1	1*
Classe de qualité - Huile ⁽¹⁾	-	-	2	1	1
Media Filtrant	fibres acrylique, cellulose	micro fibres de borosilicate			charbon actif
Température de fct. [°C]	1,5 à 65	1,5 à 65	1,5 à 65	1,5 à 65	1,5 à 45
DP (élément neuf) [mbar]	10	20	50	80	60

	V		Z (ZP)		Y		X (XP)		A	
	ZANDER	EVOAIR	ZANDER	EVOAIR	ZANDER	EVOAIR	ZANDER	EVOAIR	ZANDER	EVOAIR
1030 V	EZA 1030 V/P AL		1030 Z	EZA 1030 Z/R AL	1030 Y	EZA 1030 Y/M AL	1030 X	EZA 1030 X/S AL	1030 A	EZA 1030 A/A AL
1050 V	EZA 1050 V/P AL		1050 Z	EZA 1050 Z/R AL	1050 Y	EZA 1050 Y/M AL	1050 X	EZA 1050 X/S AL	1050 A	EZA 1050 A/A AL
1070 V	EZA 1070 V/P AL		1070 Z	EZA 1070 Z/R AL	1070 Y	EZA 1070 Y/M AL	1070 X	EZA 1070 X/S AL	1070 A	EZA 1070 A/A AL
1140 V	EZA 1140 V/P AL		1140 Z	EZA 1140 Z/R AL	1140 Y	EZA 1140 Y/M AL	1140 X	EZA 1140 X/S AL	1140 A	EZA 1140 A/A AL
2010 V	EZA 2010 V/P AL		2010 Z	EZA 2010 Z/R AL	2010 Y	EZA 2010 Y/M AL	2010 X	EZA 2010 X/S AL	2010 A	EZA 2010 A/A AL
2020 V	EZA 2020 V/P AL		2020 Z	EZA 2020 Z/R AL	2020 Y	EZA 2020 Y/M AL	2020 X	EZA 2020 X/S AL	2020 A	EZA 2020 A/A AL
2030 V	EZA 2030 V/P AL		2030 Z	EZA 2030 Z/R AL	2030 Y	EZA 2030 Y/M AL	2030 X	EZA 2030 X/S AL	2030 A	EZA 2030 A/A AL
2050 V	EZA 2050 V/P AL		2050 Z	EZA 2050 Z/R AL	2050 Y	EZA 2050 Y/M AL	2050 X	EZA 2050 X/S AL	2050 A	EZA 2050 A/A AL
3050 V	EZA 3050 V/P AL		3050 Z	EZA 3050 Z/R AL	3050 Y	EZA 3050 Y/M AL	3050 X	EZA 3050 X/S AL	3050 A	EZA 3050 A/A AL
3075 V	EZA 3075 V/P AL		3075 Z	EZA 3075 Z/R AL	3075 Y	EZA 3075 Y/M AL	3075 X	EZA 3075 X/S AL	3075 A	EZA 3075 A/A AL
5060 V	EZA 5060 V/P AL		5060 Z	EZA 5060 Z/R AL	5060 Y	EZA 5060 Y/M AL	5060 X	EZA 5060 X/S AL	5060 A	EZA 5060 A/A AL
5075 V	EZA 5075 V/P AL		5075 Z	EZA 5075 Z/R AL	5075 Y	EZA 5075 Y/M AL	5075 X	EZA 5075 X/S AL	5075 A	EZA 5075 A/A AL

NOTE: * Valide si une cartouche filtrante "S" est installée en amont.

ELEMENTS FILTRANTS ALTERNATIFS STERILEMENTS



ZANDER

	HB	ST-R	BL
ZANDER Stainless steel end caps 1.4301 (304)			
	Retention particules	0,01 µm	0,01 µm
Classe de qualité - solides ⁽¹⁾	1	1	1
Classe de qualité - Huile ⁽¹⁾	-	-	-
Media Filtrant	micro fibres de borosilicate		
Température de fct.[°C]	-20 à 150	-20 à 150	-20 à 150
DP (élément neuf) [mbar]	80 mbar	80 mbar	80 mbar

	HB		ST-R		BL	
	ZANDER	EVOAIR	ZANDER	EVOAIR	ZANDER	EVOAIR
	HB 09 T	EZA 09T ST-R	ST-R 1080	EZA 1080 ST-R	BL 1160	EZA 1160 BE
	HB 13 T	EZA 13T ST-R	ST-R 1160	EZA 1160 ST-R	BL 2026	EZA 2026 BE
	HB 14 T	EZA 14T ST-R	ST-R 2016	EZA 2016 ST-R	BL 2038	EZA 2038 BE
	HB 18 T	EZA 18T ST-R	ST-R 2026	EZA 2026 ST-R	BL 2055	EZA 2055 BE
	HB 19 T	EZA 19T ST-R	ST-R 2038	EZA 2038 ST-R	BL 3055	EZA 3055 BE
			ST-R 2055	EZA 2055 ST-R	BL 3080	EZA 3080 BE
			ST-R 3055	EZA 3055 ST-R		
			ST-R 3080	EZA 3080 ST-R		



ELEMENTS FILTRANTS ALTERNATIFS DE PROCESS

ZANDER

ZANDER EMBOUTS INOX 1.4301 (304)	D 25 µm	D 1 µm	V
			
Retention particules	20 µm	1 µm	3 µm
Classe de qualité - solides ⁽¹⁾	-	-	6
Classe de qualité - Huile ⁽¹⁾	-	-	-
Media Filtrant	sintered inox		fibres acrylique, cellulose
Température de fct.[°C]	0 - 150	0 - 150	1,5 à 65
DP (élément neuf) [mbar]	60	60	10

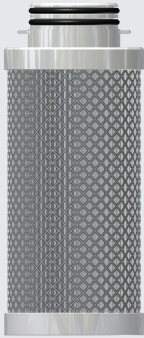

	D 25 µm		D 1 µm		V	
	ZANDER	EVOAIR	ZANDER	EVOAIR	ZANDER	EVOAIR
D 09T 25µm	EZA 09T D/PIW 20mic	D 09T 1µm	EZA 09T D/PIW 1mic	V 09 T	EZA 09T V/P	
D 13T 25µm	EZA 13T D/PIW 20mic	D 13T 1µm	EZA 13T D/PIW 1mic	V 13 T	EZA 13T V/P	
D 14T 25µm	EZA 14T D/PIW 20mic	D 14T 1µm	EZA 14T D/PIW 1mic	V 14 T	EZA 14T V/P	
D 18T 25µm	EZA 18T D/PIW 20mic	D 18T 1µm	EZA 18T D/PIW 1mic	V 18 T	EZA 18T V/P	
D 19T 25µm	EZA 19T D/PIW 20mic	D 19T 1µm	EZA 19T D/PIW 1mic	V 19 T	EZA 19T V/P	

NOTE: * Valide si une cartouche filtrante "S" est installée en amont.

ZANDER EMBOUTS INOX 1.4301 (304)	ZP	XP	A
			
Retention particules	1 µm	0,01 µm	charbon actif
Classe de qualité - solides ⁽¹⁾	3	1	1*
Classe de qualité - Huile ⁽¹⁾	-	1	1
Media Filtrant	micro fibres de borosilicate		charbon actif
Température de fct.[°C]	1,5 à 65	1,5 à 65	1,5 à 45
DP (élément neuf) [mbar]	20	80	60

	ZP		XP		A	
	ZANDER	EVOAIR	ZANDER	EVOAIR	ZANDER	EVOAIR
	ZP 09 T	EZA 09T ZP/R	XP 09 T	EZA 09T XP/S	A 09 T	EZA 09T A/A
	ZP 13 T	EZA 13T ZP/R	XP 13 T	EZA 13T XP/S	A 13 T	EZA 13T A/A
	ZP 14 T	EZA 14T ZP/R	XP 14 T	EZA 14T XP/S	A 14 T	EZA 14T A/A
	ZP 18 T	EZA 18T ZP/R	XP 18 T	EZA 18T XP/S	A 18 T	EZA 18T A/A
	ZP 19 T	EZA 19T ZP/R	XP 19 T	EZA 19T XP/S	A 19 T	EZA 19T A/A

ZONDER

ZONDER Embouts Plastique	MBM	MBS
		
Retention particules	0,1 µm	0,01 µm
Classe de qualité - solides ⁽¹⁾	2	1
Classe de qualité - Huile ⁽¹⁾	2	1
Media Filtrant	micro fibres de borosilicate	
Température de fct. [°C]	1,5 à 65	1,5 à 65
DP (élément neuf) [mbar]	50	80

ZONDER	MBM		MBS	
	ZONDER	EVOAIR	ZONDER	EVOAIR
MBM 10	EZO 10 MBM/M	MBS 10	EZO 10 MBS/S	
MBM 13	EZO 13 MBM/M	MBS 13	EZO 13 MBS/S	
MBM 20	EZO 20 MBM/M	MBS 20	EZO 20 MBS/S	
MBM 33	EZO 33 MBM/M	MBS 33	EZO 33 MBS/S	
MBM 60	EZO 60 MBM/M	MBS 60	EZO 60 MBS/S	
MBM 85	EZO 85 MBM/M	MBS 85	EZO 85 MBS/S	
MBM 130	EZO 130 MBM/M	MBS 130	EZO 130 MBS/S	
MBM 170	EZO 170 MBM/M	MBS 170	EZO 170 MBS/S	
MBM 250	EZO 250 MBM/M	MBS 250	EZO 250 MBS/S	
MBM 400	EZO 400 MBM/M	MBS 400	EZO 400 MBS/S	

EVOAIR

Traitement de l'Air & des Gaz



COPRS DE FILTRE ALTERNATIFS

120 **DONALDSON**

120 **DOMNICK HUNTER**

ELEMENTS SEPARATEURS EAU/HUILE ALTERNATIFS

122 **JORC**
(Boge)

122 **BEKO**
(Atlas Copco, Kaeser, Ecoair, Schnider)

122 **WORTMANN**
(Zander, Kaeser, Hankinson)

123 **DOMNICK HUNTER**
(Hiross, Zander, Hiross, Compair, Ingersoll Rand)

123 **DONALDSON**
(Almig, Gardner Denver)

123 **KAESER**

124 **ATLAS COPCO**
(Alup, Abac)

124 **OMI**
(Devair)

CARTOUCHES DESSICANT ALTERNATIVES POUR SECHEURS

125 **DONALDSON**
Ultracac 2000

KITS DE MAINTENANCE SECHEURS ALTERNATIFS

126 **HANKISON**



**COPRS DE FILTRE
ALTERNATIF**

DONALDSON / DOMNICK HUNTER

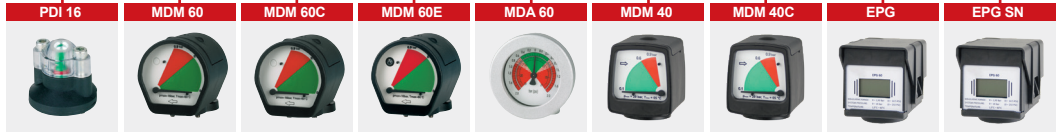
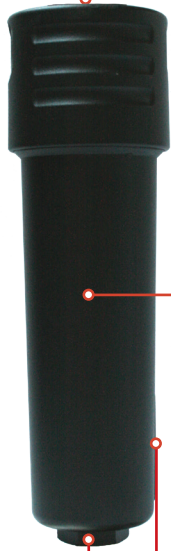

DONALDSON series 90' - Embouts plastique



DONALDSON series 90' - Embouts aluminium



DOMNICK HUNTER series oil-x plus - Embouts plastique



DOMNICK HUNTER séries oil-x plus - Embouts aluminium



DONALDSON ALTERNATIVE FILTER HOUSINGS

Modele de filtre	Diametres tuyauteries	Debits	Dimensions				Poids	Type d'element filtrants
	inch		Nm ³ /h	A [mm]	B [mm]	C [mm]		
FD 0002	1/4"	20	196	80	21	60	0,439	02/05
FD 0004	3/8"	40	196	80	21	60	0,436	03/05
FD 0006	3/8"	60	196	80	21	60	0,436	03/10
FD 0009	1/2"	90	266	80	21	80	0,760	04/10
FD 0012	1/2"	120	263	117	33	100	1,182	04/20
FD 0018	3/4"	180	363	117	33	120	1,575	05/20
FD 0027	1"	270	363	117	33	140	1,558	05/25
FD 0036	1 1/4"	360	363	117	33	160	1,573	07/25
FD 0048	1 1/2"	480	700	140	50	320	3,017	07/30
FD 0072	2"	720	700	140	50	320	2,862	10/30
FD 0108	2"	1080	700	140	50	520	5,329	15/30
FD 0144	2 1/2"	1440	811	217	69	630	13,144	20/30
FD 0192	3"	1920	811	217	69	630	12,794	30/30
FD 0288	3"	2880	1000	217	69	750	15,756	30/50

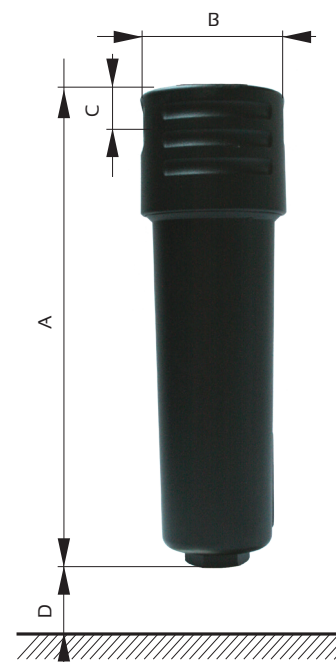
**DOMNICK HUNTER COPRS DE FILTRES ALTERNATIF**

Modele de filtre	Diametres tuyauteries	Debits	Dimensions				Poids	Type d'element filtrants
	inch		Nm ³ /h	A [mm]	B [mm]	C [mm]		
FDH 009	1/4"	32	196	80	21	60	0,547	009
FDH 017	3/8"	61	266	80	21	60	0,545	017
FDH 030	1/2"	108	266	80	21	60	0,760	030
FDH 058	3/4"	216	363	117	33	120	2,245	058
FDH 080	1"	288	461	117	33	260	1,880	145
FDH 120	1 1/4"	432	461	117	33	260	1,895	145
FDH 145	1 1/2"	522	461	117	33	260	2,504	145
FDH 205	1 1/2"	720	700	140	50	320	3,028	220
FDH 220	2"	792	700	140	50	320	2,876	220
FDH 330	2"	1188	950	140	50	520	7,224	330
FDH 400	2 1/2"	1440	811	217	69	630	13,501	430
FDH 430	3"	1548	811	217	69	630	13,060	430
FDH 620	3"	2232	1000	217	69	750	9,797	620

FACTEURS DE CORRECTION

Pression service [bar]	2	3	4	5	6	7	8	9	10	11	12	13	14	15	16
Facteur de correction	0,38	0,52	0,63	0,75	0,88	1,00	1,13	1,26	1,38	1,52	1,65	1,76	1,87	2,00	2,14



ELEMENTS SEPARATEUR EAU/HUILE ALTERNATIFS

FABRICANT	COMPATIBLE SEPARATEURS	EVOAIR	CONTENU DU KIT
JORC	BOGE		
Puro Mini	CC 4	EJO Puro Mini	1xAC, 1xPP
Puro	CC 8	EJO Puro	1xAC, 1xPP
Puro Midi	CC 20	EJO Puro Midi	1xAC, 1xPP
Puro Grand	CC 35	EJO Puro Grand	1xAC, 1xPP
Xtender	Extender	EJO Xtender	1xAC
SEPREMIUM 5	-	EJO SEP5	1xAC, 2xPP*
SEPREMIUM 10	-	EJO SEP10	1xAC, 2xPP
SEPREMIUM 20	-	EJO SEP20	1xAC, 2xPP
SEPREMIUM 30	-	EJO SEP30	2xAC*, 2xPP

FABRICANT	COMPATIBLE SEPARATEURS				EVOAIR	CONTENU DU KIT
BEKO (BOGE)	ATLAS COPCO	KAESER	ECOAIR	SCHNEIDER		
ÖWAMAT 1 / 2	OSW 5 / 11	AQUAMAT 1 / 2	-	OWATEC 10 / 40	EBK OWM 1,2	1xAC, 1xPP
ÖWAMAT 3	-	AQUAMAT 3	TS 3	-	EBK OWM 3	1xAC*
ÖWAMAT 4	OSW 30	AQUAMAT 4	TS 4	OWATEC 130	EBK OWM 4	1xAC, 1xPP
ÖWAMAT 5	-	AQUAMAT 5	TS 15	-	EBK OWM 5	2xAC
ÖWAMAT 5R	OSW 55	AQUAMAT 5R	-	OWATEC 175	EBK OWM 5R	1xAC, 1xPP
ÖWAMAT 6	OSW 110	AQUAMAT 6	TS 16	OWATEC 250	EBK OWM 6	2xAC*, 1xPP
ÖWAMAT 8	OSW 315	AQUAMAT 8	-	-	EBK OWM 8	2xAC*, 1xPP
ÖWAMAT 10					EBK OWM 10	1xAC+PP
ÖWAMAT 11					EBK OWM 11	1xAC+PP
ÖWAMAT 20	-	AQUAMAT 20	TS 60	-	EBK OWM 20	1xAC

FABRICANT	COMPATIBLE SEPARATEURS					EVOAIR	CONTENU DU KIT
WORTMANN	EKOLOG	WORTMANN / KAESER	HANKISON		ZANDER		
DRUKOMAT 1/ MINI	EKOLOG 1/ MINI		HSMK1	HS 60, 120	ECOSEP S1/ mini	EWO DRM 1, mini	1x1085W, 1x1088L
DRUKOMAT 2	EKOLOG 2	WOI-II	HSMK2	HS 140-480	ECOSEP S2	EWO DRM 2,4,8	1x1087W, 1x1088L
DRUKOMAT 4	EKOLOG 4	WOI-II	HSMK3	HS 140-480	ECOSEP S4	EWO DRM 2,4,8	1x1087W, 1x1088L
DRUKOMAT 8	EKOLOG 8	WOI-II	HSMK4	HS 140-480	ECOSEP S8	EWO DRM 2,4,8	1x1087W, 1x1088L
DRUKOMAT 15	EKOLOG 15	WOI-II	HSMK5	HS 900	ECOSEP S15	EWO DRM 15	1x1094VF, 1x1087W, 1x1088L
DRUKOMAT 30	EKOLOG 30	WOIII	HSMK6	HS 1800	ECOSEP S30	EWO DRM 30	1x1094VF, 2x1087W, 1x1088L
DRUKOMAT 61	EKOLOG 61	WOIV	HSMK7	HS 3600	ECOSEP S61	EWO DRM 61	1x1094VF, 4x1087W, 1x4/1094VF*, 1x1088L
DRUKOSEP 1						EWO DRS 1	1xAC+PP
DRUKOSEP 2						EWO DRS 2	1xAC+PP
DRUKOSEP 3						EWO DRS 3	1xAC+PP
DRUKOSEP 6						EWO DRS 6	1xAC+PP
DRUKOSEP 8						-	-
DRUKOSEP 10						-	-

FABRICANT	COMPATIBLE SEPARATEURS						EVOAIR	CONTENU DU KIT
DOMNICK HUNTER ES	DOMNICK HUNTER H2 OIL-X	DOMNICK HUNTER ES	HIROSS OWS	ZANDER ECOSEP SL	COMPAIR CS	INGERSOLL RAND ENVIROSEP		
	SE2010						EDH SE2010	1xAC, 1xPP
	SE2015						EDH SE2015	1xAC, 1xPP
	SE2030						EDH SE2030	2xAC*, 1xPP
ES2100		ES36	OWS 001	SL1*	CS2100	ECS 6	EDH ES2100	1xAC, 1xPP
ES2150		ES90	OWS 060	SL2*	CS2150	ECS 12	EDH ES2150	1xAC, 1xPP
ES2200			OWS 075	SL5*	CS2200	ECS 18	EDH ES2200	1xAC, 1xPP
ES2300		ES125	OWS 125	SL8*	CS2300	ECS 24	EDH ES2300	1xAC, 1xPP
ES2400		ES250	OWS 185	SL15*	CS2400	ECS 30	EDH ES2400	2xAC, 2xPP
ES2500		ES500	OWS 355	SL30*	CS2500	ECS 36	EDH ES2500	1xAC, 1xPP
ES2600		ES1000	OWS 485	SL60*	CS2600	ECS 42	EDH ES2600	2xAC, 2xPP

FABRICANT	COMPATIBLE SEPARATEURS		EVOAIR	CONTENU DU KIT
DONALDSON	ALMIG AQUAMAT	GARDNER DENVER		

Ultrasep Plus

ULTRASEP P7,5			EDO UP7,5	1xAC
ULTRASEP P15			EDO UP15	1xAC
ULTRASEP P30			EDO UP30	1xAC
ULTRASEP P60			EDO UP60	2xAC
ULTRASEP P120			EDO UP120	4xAC
ULTRASEP P240			EDO UP240	8xAC

Ultrasep Super Plus

ULTRASEP SP5		GDW 5	-	-
ULTRASEP SP7,5/ 10		GDW 10	-	-
ULTRASEP SP15		GDW 15	EDO USP15	1xAC, 1xPP*
ULTRASEP SP30		GDW 30	EDO USP30	2xAC, 1xPP
ULTRASEP SP60		GDW 60	EDO USP60	2xAC, 1xPP
ULTRASEP SP120		GDW 120	EDO USP120	4xAC, 2xPP
ULTRASEP SP240		GDW 240	EDO USP240	8xAC, 4xPP

Ultrasep Super Plus - N

ULTRASEP SP5	120	GDW 5	-	-
ULTRASEP SP10N	250	GDW 10N	EDO USP10N	1xAC+PP
ULTRASEP SP15N	450	GDW 15N	EDO USP15N	1xAC+PP
ULTRASEP SP30N	900	GDW 30N	EDO USP30N	1xAC+PP, 1xAC
ULTRASEP SP60N	1800	GDW 60N	EDO USP60N	1xAC+PP, 1xAC
ULTRASEP SP120N	3600	GDW 120N	EDO USP120N	2xAC+PP, 2xAC
ULTRASEP SP240N	7200	GDW 240N	EDO USP240N	4xAC+PP, 4xAC

FABRICANT	EVOAIR	CONTENU DU KIT
KAESER		
AQUAMAT CF3	EKA ACF3	1xAC+PP
AQUAMAT CF6	EKA ACF6	1xAC+PP

FABRICANT		COMPATIBLE SEPARATEURS			EVOAIR	CONTENU DU KIT
ATLAS COPCO		ALUP OWS	ABAC WS	PNEVMATEC		
OSC35	Service kit A	OWS13	WS13	OWS-75	EAC OSC 35 - A	1xPP
	Service kit B				EAC OSC 35 - B	1xAC, 2xPP
	Service kit C				EAC OSC 35 - C	1xAC, 1xPP
OSC95	Service kit A	OWS34	WS34	OWS-200	EAC OSC 95 - A	1xPP
	Service kit B				EAC OSC 95 - B	1xAC, 2xPP
	Service kit C				EAC OSC 95 - C	1xAC, 1xPP
OSC145	Service kit A	OWS52	WS52	OWS-300	EAC OSC 145 - A	1xPP
	Service kit B				EAC OSC 145 - B	1xAC, 2xPP
	Service kit C				EAC OSC 145 - C	1xAC, 1xPP
OSC355	Service kit A	OWS128	WS128	OWS-750	EAC OSC 355 - A	2xPP
	Service kit B				EAC OSC 355 - B	2xAC, 4xPP
	Service kit C				EAC OSC 355 - C	2xAC, 2xPP
OSC600	Service kit A	OWS218	WS218	OWS-1280	EAC OSC 600 - A	2xPP
	Service kit B				EAC OSC 600 - B	2xAC, 4xPP
	Service kit C				EAC OSC 600 - C	2xAC, 2xPP
OSC825	Service kit A	OWS297	WS297	OWS-1750	EAC OSC 825 - A	2xPP
	Service kit B				EAC OSC 825 - B	4xAC*, 4xPP
	Service kit C				EAC OSC 825 - C	4xAC*, 2xPP
OSC1200	Service kit A	OWS425	WS425	OWS-2500	EAC OSC 1200 - A	2xPP
	Service kit B				EAC OSC 1200 - B	4xAC*, 4xPP
	Service kit C				EAC OSC 1200 - C	4xAC*, 2xPP
OSC2400	Service kit A	OWS850	WS850	OWS-5000	EAC OSC 2400 - A	4xPP
	Service kit B				EAC OSC 2400 - B	8xAC*, 8xPP
	Service kit C				EAC OSC 2400 - C	8xAC*, 4xPP

FABRICANT	COMPATIBLE SEPARATEURS	EVOAIR	CONTENU DU KIT
OMI	DEVAIR		
ECOTRON 25	ECOTRON 25	EOM KTRON 25	1xAC, 1xPP
ECOTRON 50	ECOTRON 50	EOM KTRON 50	1xAC, 2xPP
ECOTRON 90	ECOTRON 90	EOM KTRON 90	1xAC, 2xPP
ECOTRON 180	ECOTRON 180	EOM KTRON 180	1xAC, 4xPP
ECOTRON 300	ECOTRON 300	EOM KTRON 300	2xAC, 2xPP
ECOTRON 600	ECOTRON 600	EOM KTRON 600	3xAC, 4xPP



CARTOUCHES ALTERNATIVE DE DESSICANT POUR SECHEURS

DONALDSON Ultrapac 2000

DONALDSON				EVOAIR
TYPE DE SÉCHEUR		TYPE D'ÉLÉMENT FILTRANT	NBR CARACHES PAR FILTRE	
US title	EU title			
UP0003-60	0005	10/2	2	EDO 10/2 MS
UP0005-60	0010	10/2	4	EDO 10/2 MS
UP0010-60	0015	10/2	6	EDO 10/2 MS
UP0015-60	0025	10/2	10	EDO 10/2 MS
UP0020-60	0035	10/4	4	EDO 10/4 MS
UP0030-60	0050	10/4	6	EDO 10/4 MS
UP0040-60	0065	10/4	8	EDO 10/4 MS
UP0050-60	0080	10/4	10	EDO 10/4 MS
UP0060-60	0100	10/4	12	EDO 10/4 MS

KITS DE MAINTENANCE ALTERNATIFS POUR SECHEURS

HANKISON

HANKISON		EVOAIR
TYPE DE SECHEUR	KIT D'ORIGINE	
HHD10 / HHD20 / HHD30	HPRMK 1	EHK HPRMK 1
HHDp50 / HHDp70	HPRMK 2	EHK HPRMK 2
HHDp100	HPRMK 3	EHK HPRMK 3
HHDp150 / HHDp210	HPRMK 4	EHK HPRMK 4
HHDp211	HPRMK 4.5	EHK HPRMK 4.5
HHDp211	HPRMK 4.5.1	EHK HPRMK 4.5.1
HHDp260 / HHDp300	HPRMK 5	EHK HPRMK 5
HHDp261 / HHDp301	HPRMK 5.5	EHK HPRMK 5.5
HHDp261 / HHDp301	HPRMK 5.5.1	EHK HPRMK 5.5.1
HHDp380	HPRMK 6	EHK HPRMK 6
HHDp381 / HHDp481	HPRMK 6.5	EHK HPRMK 6.5
HHDp381 / HHDp481	HPRMK 6.5.1	EHK HPRMK 6.5.1
HHDp480 / HHDp600	HPRMK 7	EHK HPRMK 7
HHDp601	HPRMK 7.5	EHK HPRMK 7.5
HHDp601	HPRMK 7.5.1	EHK HPRMK 7.5.1
HHDp750 / HHDp950	HPRMK 8	EHK HPRMK 8
HHDp791	HPRMK 8.3	EHK HPRMK 8.3
HHDp791	HPRMK 8.3.1	EHK HPRMK 8.3.1
HHDp951 / HHDp1151	HPRMK 8.6	EHK HPRMK 8.6
HHDp951 / HHDp1151	HPRMK 8.6.1	EHK HPRMK 8.6.1
HHDp1450	HPRMK 9	EHK HPRMK 9
HHDp1451	HPRMK 9.5	EHK HPRMK 9.5
HHDp1451	HPRMK 9.5.1	EHK HPRMK 9.5.1
HD11 / HD22	RDMK1	EHK RDMK1
HD33/HD55/HD75 (8015, 8025, 8035)	RDMK2	EHK RDMK2
HD33 / HD55 / HD75	RDMK2-M	EHK RDMK2-M
HD105	RDMK4	EHK RDMK4
HD150 / HD220 / HD270 / HD305	RDMK5	EHK RDMK5
HD390 / HD490	RDMK7	EHK RDMK7

IMPORTANT

En tant que spécialiste des équipements de filtration EVOAIR offre une des plus complètes game d'élément filtrants alternatifs. Nos éléments filtrants sont conçue pour prendre place des éléments filtrants originaux des fabricants. Filter elements are designed à fit à original manufacturers equipment tandis que notre savoir faire est mise en oeuvre pour obtenir la qualité d'air comprimé requise.

Malgré le fait que certaines dimensions ou certains détails diffèrent des pièces d'origine, nos éléments de filtre alternatifs s'adaptent aux corps de filtre originaux.

En raison de l'amélioration continue de nos produits, les spécifications et les apparences peuvent changer sans préavis.

EMBOUTS GRAVÉS



EMBOUTS IMPRIMÉS



CONDITIONS GÉNÉRALES DE VENTE

Conditions générales:	Exclusivement valable "Les conditions générales de vente" de la société evoair.
Conditions de livraison:	Incoterms EXW Gamaches (80), emballage inclus.
Modalités de paiement:	Paiement à l'avance, sauf accord contraire. La devise est l'EURO.
Garantie:	un an à partir de la date de livraison. La garantie ne s'applique que si le produit est utilisé conformément à son mode d'emploi. les autres coûts tels que les coûts de main-d'œuvre ne sont pas inclus.
Changements:	Nous nous réservons le droit aux erreurs de frappe et de modifier les prix, les conditions et les spécifications techniques des produits sans annonce préalable.
Emballage et traitement des déchets:	Le client destinataire est responsable du recyclage de l'emballage et de l'élimination des déchets d'équipements électriques conformément aux directives locales.
Droit de propriété:	Les produits livrés restent en notre possession jusqu'au règlement complet du paiement.

Les conditions de vente mentionnées ci-dessus sont données à titre indicatif et sont disponible sur demande.
 Àus les autres détails sont définis dans un accord écrit entre les parties au contrat.

ELEMENTS FILTRANTS ALTERNATIFS

DEMANDE DE DEVIS

CLIENT	
Société:	
Adresse:	
Contact :	
Fonction:	
N° de téléphone:	
N° de mobile :	
E-mail:	
Reference/Client:	

evoair

AIR COMPRIMÉ

65 rue du 11 Novembre
80220 GAMACHES

T. +33 (0)3 22 26 82 12
Contact@evoair.fr

Pour obtenir votre offre, remplissez cette demande
et faite la nous parvenir par e-mail

Fabricant de la cartouche filtrante	Fabricant du corps de filtre	Référence d'origine / Type de filtration	Quantité	
Remarques/Notes:				

Equipement	Fabricant	Type	Puissance [kW]	Année de fabrication
Compresseurs				
Sécheurs				

Si vous n'arrivez pas à identifier le type de la cartouche d'origine, merci d'indiquer dans le tableau de la page suivante le type correspondant, les dimensions, et le grade de filtration.

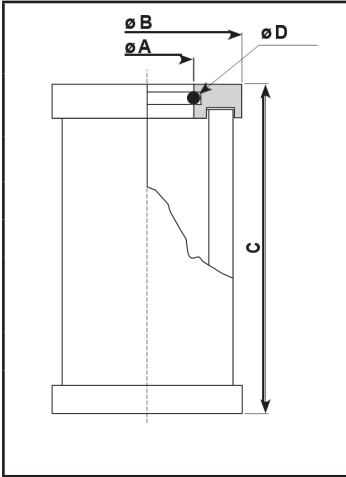

Type 1

Type de filtration			Merci de remplir la table ci dessous si la reference de cartouche est inconnue							Quantité		
Industriel	Stérile	Process	Grade de filtration	Dimensions [mm]								
			µm	A	B	C	D	E	F			
Demande complementaires/ notes:												

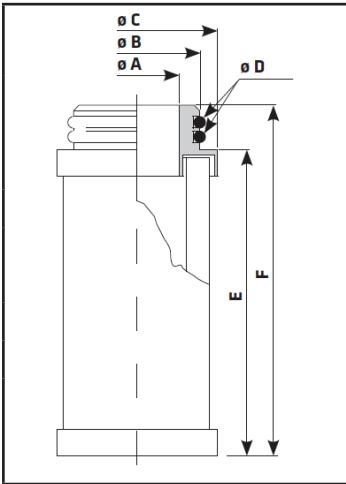

Type 2

Type de filtration			Merci de remplir la table ci dessous si la reference de cartouche est inconnue							Quantité		
Industriel	Stérile	Process	Grade de filtration	Dimensions [mm]								
			µm	A	B	C	D	E	F			
Demande complementaires/ notes:												

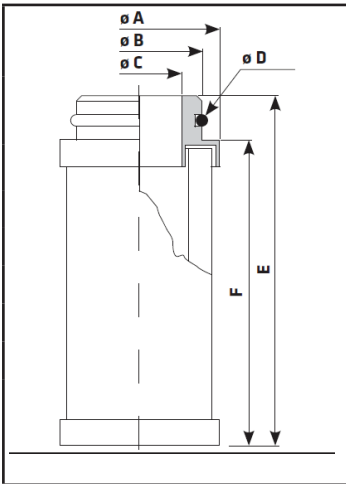

Type 3

Type de filtration			Merci de remplir la table ci dessous si la reference de cartouche est inconnue							Quantité		
Industriel	Stérile	Process	Grade de filtration	Dimensions [mm]								
			µm	A	B	C	D	E	F			
Demande complementaires/ notes:												

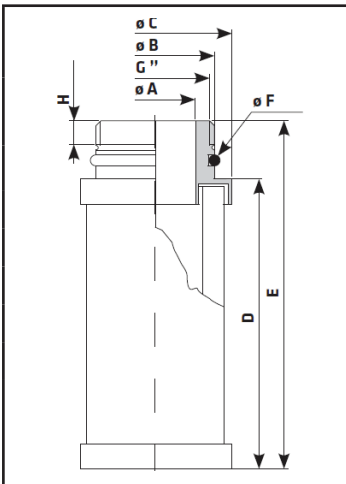

Type 4

Type de filtration			Merci de remplir la table ci dessous si la reference de cartouche est inconnue								Quantité		
Industriel	Stérile	Process	Grade de filtration	Dimensions [mm]									
			µm	A	B	C	D	E	F	G''			H
Demande complementaires/ notes:													

Pour tout autre type merci de nous adresser des photos avec les cotes ci dessus

EVOAIR

AIR COMPRIME



evoair
AIR COMPRIMÉ

T +33 (0)3 22 26 82 12

contact@evoair.fr

65, rue du onze Novembre
80220 - GAMACHES - France
www.evoair.fr